

User and Project Details

Project:	Coral Reef Junction Improvements
Title:	Proposed Crossroads
Location:	
File name:	CR Final Layout 20140707.lsg3x
Author:	Graham Waite
Company:	BFC
Address:	
Notes:	

Network Layout Diagram

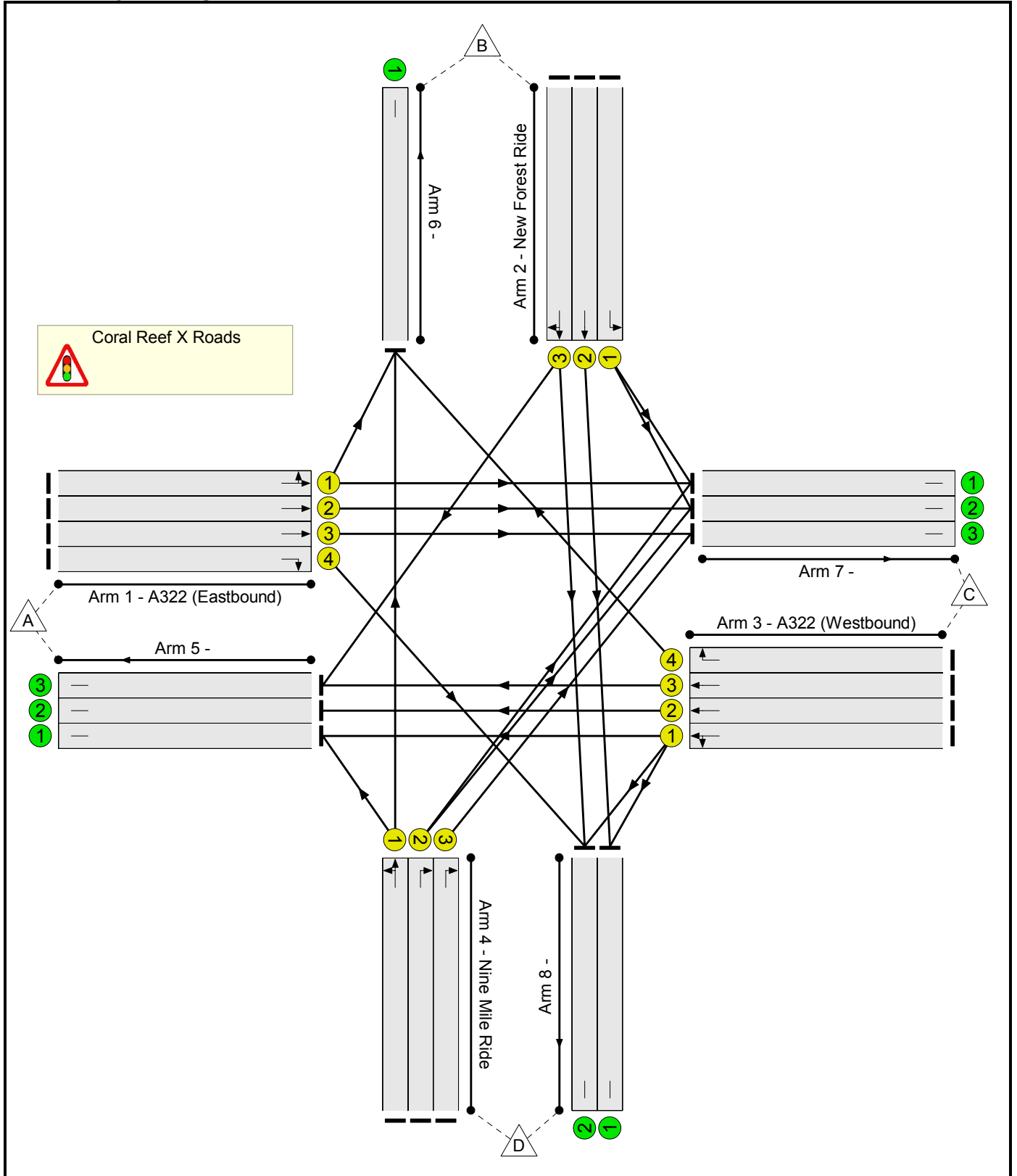

Phase Diagram

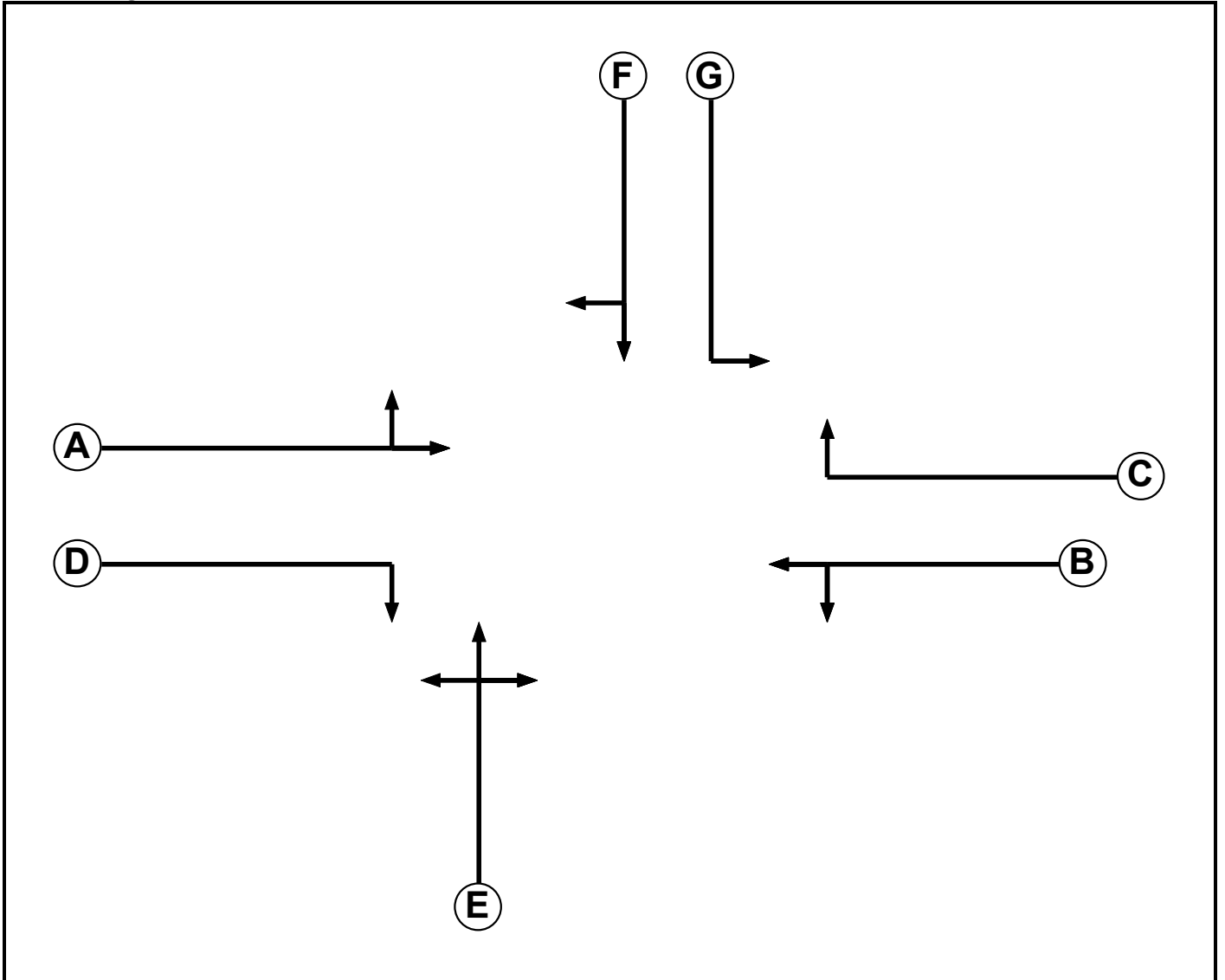

Phase Input Data

Phase Name	Phase Type	Assoc. Phase	Street Min	Cont Min
A	Traffic		7	7
B	Traffic		7	7
C	Traffic		7	7
D	Traffic		7	7
E	Traffic		7	7
F	Traffic		7	7
G	Traffic		7	7

Phase Intergreens Matrix

		Starting Phase						
		A	B	C	D	E	F	G
Terminating Phase	A	-	-	5	-	5	7	9
	B	-	-	-	5	8	5	-
	C	7	-	-	-	6	5	-
	D	-	6	-	-	5	5	-
	E	6	5	5	5	-	7	8
	F	5	5	5	5	5	-	-
	G	5	-	-	-	5	-	-

Phases in Stage

Stage No.	Phases in Stage
1	A B
2	F G
3	E
4	C D G
5	A D
6	F G
7	B C G
8	E

Stage Diagram

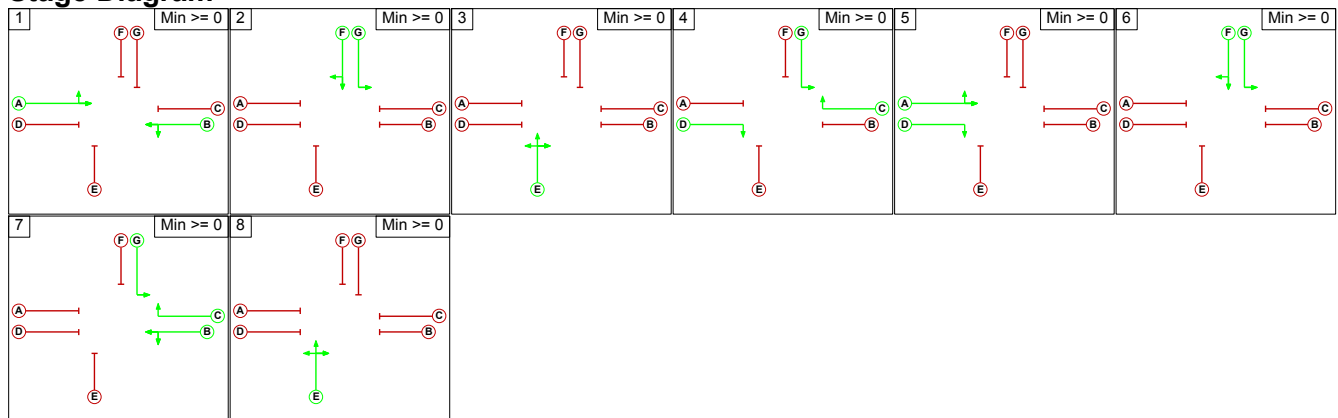

Phase Delays

Term. Stage	Start Stage	Phase	Type	Value	Cont value
1	6	B	Losing	1	1
4	3	C	Losing	1	1
4	3	D	Losing	1	1
4	6	D	Losing	1	1
4	8	C	Losing	1	1
4	8	D	Losing	1	1
5	2	D	Losing	2	2
5	6	D	Losing	2	2
7	3	B	Losing	1	1
7	3	C	Losing	1	1
7	8	B	Losing	1	1
7	8	C	Losing	1	1

Prohibited Stage Change

		To Stage							
		1	2	3	4	5	6	7	8
From Stage	1		X	X	9	5	9	9	8
	2	5		X	X	5	0	5	5
	3	X	8		X	6	8	8	0
	4	X	X	7		7	6	6	7
	5	6	9	5	9		9	9	5
	6	5	0	5	5	5		5	5
	7	7	5	9	5	7	5		9
	8	6	8	0	8	6	8	8	

Full Input Data And Results
CR Final Layout 20140707.lsg3x

Give-Way Lane Input Data

Junction: Coral Reef X Roads
There are no Opposed Lanes in this Junction

Lane Input Data

Junction: Coral Reef X Roads												
Lane	Lane Type	Phases	Start Disp.	End Disp.	Physical Length (PCU)	Sat Flow Type	Def User Saturation Flow (PCU/Hr)	Lane Width (m)	Gradient	Nearside Lane	Turns	Turning Radius (m)
1/1 (A322 Eastbound))	U	A	2	3	60.0	Geom	-	3.60	0.00	Y	Arm 6 Left	Inf
											Arm 7 Ahead	Inf
1/2 (A322 Eastbound))	U	A	2	3	60.0	Geom	-	3.60	0.00	N	Arm 7 Ahead	Inf
1/3 (A322 Eastbound))	U	A	2	3	60.0	Geom	-	3.60	0.00	N	Arm 7 Ahead	Inf
1/4 (A322 Eastbound))	U	D	2	3	15.0	Geom	-	3.60	0.00	N	Arm 8 Right	Inf
2/1 (New Forest Ride)	U	G	2	3	10.0	Geom	-	4.00	0.00	Y	Arm 7 Left	20.00
2/2 (New Forest Ride)	U	F	2	3	60.0	Geom	-	4.00	0.00	N	Arm 8 Ahead	Inf
2/3 (New Forest Ride)	U	F	2	3	8.0	Geom	-	4.00	0.00	N	Arm 5 Right	Inf
											Arm 8 Ahead	Inf
3/1 (A322 Westbound))	U	B	2	3	60.0	Geom	-	3.60	0.00	Y	Arm 5 Ahead	Inf
											Arm 8 Left	30.00
3/2 (A322 Westbound))	U	B	2	3	60.0	Geom	-	3.60	0.00	N	Arm 5 Ahead	Inf
3/3 (A322 Westbound))	U	B	2	3	60.0	Geom	-	3.70	0.00	N	Arm 5 Ahead	Inf
3/4 (A322 Westbound))	U	C	2	3	25.0	Geom	-	3.60	0.00	N	Arm 6 Right	Inf
4/1 (Nine Mile Ride)	U	E	2	3	60.0	Geom	-	3.65	0.00	N	Arm 5 Left	15.00
											Arm 6 Ahead	Inf
4/2 (Nine Mile Ride)	U	E	2	3	15.0	Geom	-	3.65	0.00	N	Arm 7 Right	30.00
4/3 (Nine Mile Ride)	U	E	2	3	15.0	Geom	-	3.65	0.00	N	Arm 7 Right	30.00
5/1	U		2	3	60.0	Inf	-	-	-	-	-	-
5/2	U		2	3	60.0	Inf	-	-	-	-	-	-

Full Input Data And Results
 CR Final Layout 20140707.lsg3x

5/3	U		2	3	60.0	Inf	-	-	-	-	-	-
6/1	U		2	3	60.0	Inf	-	-	-	-	-	-
7/1	U		2	3	60.0	Inf	-	-	-	-	-	-
7/2	U		2	3	60.0	Inf	-	-	-	-	-	-
7/3	U		2	3	60.0	Inf	-	-	-	-	-	-
8/1	U		2	3	60.0	Inf	-	-	-	-	-	-
8/2	U		2	3	60.0	Inf	-	-	-	-	-	-

Traffic Flow Groups

Flow Group	Start Time	End Time	Duration	Formula
1: '2013 Observed AM'	08:00	09:00	01:00	
2: '2013 Observed PM'	17:00	18:00	01:00	
3: '2026 M3 AM'	08:00	09:00	01:00	
4: '2026 M3 PM'	17:00	18:00	01:00	
5: '2013 Observed AM 90%'	08:00	09:00	01:00	F1*0.9
6: '2013 Observed PM 90%'	17:00	18:00	01:00	F2*0.9
7: '2026 M3 AM 90%'	08:00	09:00	01:00	F3*0.9
8: '2026 M3 PM 90%'	17:00	18:00	01:00	F4*0.9

Scenario 1: '2013 AM Peak' (FG1: '2013 Observed AM', Plan 3: 'Option 3')

Traffic Flows, Desired

Desired Flow :

	Destination					
	A	B	C	D	Tot.	
Origin	A	2	68	1446	114	1630
	B	56	0	155	227	438
	C	1671	97	5	383	2156
	D	71	186	393	0	650
	Tot.	1800	351	1999	724	4874

Traffic Lane Flows

Lane	Scenario 1: 2013 AM Peak
Junction: Coral Reef X Roads	
1/1	473
1/2	520
1/3	521
1/4	114
2/1	155
2/2	142
2/3	141
3/1	629
3/2	711
3/3	714
3/4	97
4/1	257
4/2	196
4/3	197
5/1	317
5/2	711
5/3	770
6/1	351
7/1	580
7/2	696
7/3	718
8/1	334
8/2	390

Lane Saturation Flows

Junction: Coral Reef X Roads								
Lane	Lane Width (m)	Gradient	Nearside Lane	Allowed Turns	Turning Radius (m)	Turning Prop.	Sat Flow (PCU/Hr)	Flared Sat Flow (PCU/Hr)
1/1 (A322 (Eastbound))	3.60	0.00	Y	Arm 6 Left	Inf	14.4 %	1975	1975
				Arm 7 Ahead	Inf	85.6 %		
1/2 (A322 (Eastbound))	3.60	0.00	N	Arm 7 Ahead	Inf	100.0 %	2115	2115
1/3 (A322 (Eastbound))	3.60	0.00	N	Arm 7 Ahead	Inf	100.0 %	2115	2115
1/4 (A322 (Eastbound))	3.60	0.00	N	Arm 8 Right	Inf	100.0 %	2115	2115
2/1 (New Forest Ride)	4.00	0.00	Y	Arm 7 Left	20.00	100.0 %	1874	1874
2/2 (New Forest Ride)	4.00	0.00	N	Arm 8 Ahead	Inf	100.0 %	2155	2155
2/3 (New Forest Ride)	4.00	0.00	N	Arm 5 Right	Inf	39.7 %	2155	2155
				Arm 8 Ahead	Inf	60.3 %		
3/1 (A322 (Westbound))	3.60	0.00	Y	Arm 5 Ahead	Inf	39.1 %	1917	1917
				Arm 8 Left	30.00	60.9 %		
3/2 (A322 (Westbound))	3.60	0.00	N	Arm 5 Ahead	Inf	100.0 %	2115	2115
3/3 (A322 (Westbound))	3.70	0.00	N	Arm 5 Ahead	Inf	100.0 %	2125	2125
3/4 (A322 (Westbound))	3.60	0.00	N	Arm 6 Right	Inf	100.0 %	2115	2115
4/1 (Nine Mile Ride)	3.65	0.00	N	Arm 5 Left	15.00	27.6 %	2063	2063
				Arm 6 Ahead	Inf	72.4 %		
4/2 (Nine Mile Ride)	3.65	0.00	N	Arm 7 Right	30.00	100.0 %	2019	2019
4/3 (Nine Mile Ride)	3.65	0.00	N	Arm 7 Right	30.00	100.0 %	2019	2019
5/1	Infinite Saturation Flow						Inf	Inf
5/2	Infinite Saturation Flow						Inf	Inf
5/3	Infinite Saturation Flow						Inf	Inf
6/1	Infinite Saturation Flow						Inf	Inf
7/1	Infinite Saturation Flow						Inf	Inf
7/2	Infinite Saturation Flow						Inf	Inf
7/3	Infinite Saturation Flow						Inf	Inf
8/1	Infinite Saturation Flow						Inf	Inf
8/2	Infinite Saturation Flow						Inf	Inf

Scenario 2: '2013 PM Peak' (FG2: '2013 Observed PM', Plan 3: 'Option 3')

Traffic Flows, Desired

Desired Flow :

	Destination					Tot.
	A	B	C	D		
Origin						
A	5	86	1587	91	1769	
B	156	0	77	287	520	
C	1704	176	7	506	2393	
D	115	199	281	0	595	
Tot.	1980	461	1952	884	5277	

Traffic Lane Flows

Lane	Scenario 2: 2013 PM Peak
Junction: Coral Reef X Roads	
1/1	525
1/2	574
1/3	574
1/4	91
2/1	77
2/2	221
2/3	222
3/1	679
3/2	763
3/3	768
3/4	176
4/1	314
4/2	140
4/3	141
5/1	288
5/2	763
5/3	924
6/1	461
7/1	547
7/2	683
7/3	715
8/1	474
8/2	410

Lane Saturation Flows

Junction: Coral Reef X Roads								
Lane	Lane Width (m)	Gradient	Nearside Lane	Allowed Turns	Turning Radius (m)	Turning Prop.	Sat Flow (PCU/Hr)	Flared Sat Flow (PCU/Hr)
1/1 (A322 (Eastbound))	3.60	0.00	Y	Arm 6 Left	Inf	16.4 %	1975	1975
				Arm 7 Ahead	Inf	83.6 %		
1/2 (A322 (Eastbound))	3.60	0.00	N	Arm 7 Ahead	Inf	100.0 %	2115	2115
1/3 (A322 (Eastbound))	3.60	0.00	N	Arm 7 Ahead	Inf	100.0 %	2115	2115
1/4 (A322 (Eastbound))	3.60	0.00	N	Arm 8 Right	Inf	100.0 %	2115	2115
2/1 (New Forest Ride)	4.00	0.00	Y	Arm 7 Left	20.00	100.0 %	1874	1874
2/2 (New Forest Ride)	4.00	0.00	N	Arm 8 Ahead	Inf	100.0 %	2155	2155
2/3 (New Forest Ride)	4.00	0.00	N	Arm 5 Right	Inf	70.3 %	2155	2155
				Arm 8 Ahead	Inf	29.7 %		
3/1 (A322 (Westbound))	3.60	0.00	Y	Arm 5 Ahead	Inf	25.5 %	1904	1904
				Arm 8 Left	30.00	74.5 %		
3/2 (A322 (Westbound))	3.60	0.00	N	Arm 5 Ahead	Inf	100.0 %	2115	2115
3/3 (A322 (Westbound))	3.70	0.00	N	Arm 5 Ahead	Inf	100.0 %	2125	2125
3/4 (A322 (Westbound))	3.60	0.00	N	Arm 6 Right	Inf	100.0 %	2115	2115
4/1 (Nine Mile Ride)	3.65	0.00	N	Arm 5 Left	15.00	36.6 %	2045	2045
				Arm 6 Ahead	Inf	63.4 %		
4/2 (Nine Mile Ride)	3.65	0.00	N	Arm 7 Right	30.00	100.0 %	2019	2019
4/3 (Nine Mile Ride)	3.65	0.00	N	Arm 7 Right	30.00	100.0 %	2019	2019
5/1	Infinite Saturation Flow						Inf	Inf
5/2	Infinite Saturation Flow						Inf	Inf
5/3	Infinite Saturation Flow						Inf	Inf
6/1	Infinite Saturation Flow						Inf	Inf
7/1	Infinite Saturation Flow						Inf	Inf
7/2	Infinite Saturation Flow						Inf	Inf
7/3	Infinite Saturation Flow						Inf	Inf
8/1	Infinite Saturation Flow						Inf	Inf
8/2	Infinite Saturation Flow						Inf	Inf

Scenario 3: '2026 M3 AM' (FG3: '2026 M3 AM', Plan 3: 'Option 3')

Traffic Flows, Desired

Desired Flow :

	Destination					Tot.
	A	B	C	D		
Origin						
A	0	17	1365	184	1566	
B	199	0	231	198	628	
C	2077	173	0	384	2634	
D	52	85	638	0	775	
Tot.	2328	275	2234	766	5603	

Traffic Lane Flows

Lane	Scenario 3: 2026 M3 AM
Junction: Coral Reef X Roads	
1/1	432
1/2	475
1/3	475
1/4	184
2/1	231
2/2	198
2/3	199
3/1	764
3/2	846
3/3	851
3/4	173
4/1	137
4/2	320
4/3	318
5/1	432
5/2	846
5/3	1050
6/1	275
7/1	690
7/2	751
7/3	793
8/1	390
8/2	376

Lane Saturation Flows

Junction: Coral Reef X Roads								
Lane	Lane Width (m)	Gradient	Nearside Lane	Allowed Turns	Turning Radius (m)	Turning Prop.	Sat Flow (PCU/Hr)	Flared Sat Flow (PCU/Hr)
1/1 (A322 (Eastbound))	3.60	0.00	Y	Arm 6 Left	Inf	3.9 %	1975	1975
				Arm 7 Ahead	Inf	96.1 %		
1/2 (A322 (Eastbound))	3.60	0.00	N	Arm 7 Ahead	Inf	100.0 %	2115	2115
1/3 (A322 (Eastbound))	3.60	0.00	N	Arm 7 Ahead	Inf	100.0 %	2115	2115
1/4 (A322 (Eastbound))	3.60	0.00	N	Arm 8 Right	Inf	100.0 %	2115	2115
2/1 (New Forest Ride)	4.00	0.00	Y	Arm 7 Left	20.00	100.0 %	1874	1874
2/2 (New Forest Ride)	4.00	0.00	N	Arm 8 Ahead	Inf	100.0 %	2155	2155
2/3 (New Forest Ride)	4.00	0.00	N	Arm 5 Right	Inf	100.0 %	2155	2155
				Arm 8 Ahead	Inf	0.0 %		
3/1 (A322 (Westbound))	3.60	0.00	Y	Arm 5 Ahead	Inf	49.7 %	1927	1927
				Arm 8 Left	30.00	50.3 %		
3/2 (A322 (Westbound))	3.60	0.00	N	Arm 5 Ahead	Inf	100.0 %	2115	2115
3/3 (A322 (Westbound))	3.70	0.00	N	Arm 5 Ahead	Inf	100.0 %	2125	2125
3/4 (A322 (Westbound))	3.60	0.00	N	Arm 6 Right	Inf	100.0 %	2115	2115
4/1 (Nine Mile Ride)	3.65	0.00	N	Arm 5 Left	15.00	38.0 %	2042	2042
				Arm 6 Ahead	Inf	62.0 %		
4/2 (Nine Mile Ride)	3.65	0.00	N	Arm 7 Right	30.00	100.0 %	2019	2019
4/3 (Nine Mile Ride)	3.65	0.00	N	Arm 7 Right	30.00	100.0 %	2019	2019
5/1	Infinite Saturation Flow						Inf	Inf
5/2	Infinite Saturation Flow						Inf	Inf
5/3	Infinite Saturation Flow						Inf	Inf
6/1	Infinite Saturation Flow						Inf	Inf
7/1	Infinite Saturation Flow						Inf	Inf
7/2	Infinite Saturation Flow						Inf	Inf
7/3	Infinite Saturation Flow						Inf	Inf
8/1	Infinite Saturation Flow						Inf	Inf
8/2	Infinite Saturation Flow						Inf	Inf

Scenario 4: '2026 M3 PM' (FG4: '2026 M3 PM', Plan 3: 'Option 3')

Traffic Flows, Desired

Desired Flow :

	Destination					Tot.
	A	B	C	D		
Origin	A	0	1	1877	74	1952
	B	27	0	288	655	970
	C	1945	86	0	342	2373
	D	40	272	256	0	568
	Tot.	2012	359	2421	1071	5863

Traffic Lane Flows

Lane	Scenario 4: 2026 M3 PM
Junction: Coral Reef X Roads	
1/1	591
1/2	643
1/3	644
1/4	74
2/1	288
2/2	341
2/3	341
3/1	710
3/2	786
3/3	791
3/4	86
4/1	312
4/2	128
4/3	128
5/1	408
5/2	786
5/3	818
6/1	359
7/1	798
7/2	851
7/3	772
8/1	512
8/2	559

Lane Saturation Flows

Junction: Coral Reef X Roads								
Lane	Lane Width (m)	Gradient	Nearside Lane	Allowed Turns	Turning Radius (m)	Turning Prop.	Sat Flow (PCU/Hr)	Flared Sat Flow (PCU/Hr)
1/1 (A322 (Eastbound))	3.60	0.00	Y	Arm 6 Left	Inf	0.2 %	1975	1975
				Arm 7 Ahead	Inf	99.8 %		
1/2 (A322 (Eastbound))	3.60	0.00	N	Arm 7 Ahead	Inf	100.0 %	2115	2115
1/3 (A322 (Eastbound))	3.60	0.00	N	Arm 7 Ahead	Inf	100.0 %	2115	2115
1/4 (A322 (Eastbound))	3.60	0.00	N	Arm 8 Right	Inf	100.0 %	2115	2115
2/1 (New Forest Ride)	4.00	0.00	Y	Arm 7 Left	20.00	100.0 %	1874	1874
2/2 (New Forest Ride)	4.00	0.00	N	Arm 8 Ahead	Inf	100.0 %	2155	2155
2/3 (New Forest Ride)	4.00	0.00	N	Arm 5 Right	Inf	7.9 %	2155	2155
				Arm 8 Ahead	Inf	92.1 %		
3/1 (A322 (Westbound))	3.60	0.00	Y	Arm 5 Ahead	Inf	51.8 %	1929	1929
				Arm 8 Left	30.00	48.2 %		
3/2 (A322 (Westbound))	3.60	0.00	N	Arm 5 Ahead	Inf	100.0 %	2115	2115
3/3 (A322 (Westbound))	3.70	0.00	N	Arm 5 Ahead	Inf	100.0 %	2125	2125
3/4 (A322 (Westbound))	3.60	0.00	N	Arm 6 Right	Inf	100.0 %	2115	2115
4/1 (Nine Mile Ride)	3.65	0.00	N	Arm 5 Left	15.00	12.8 %	2093	2093
				Arm 6 Ahead	Inf	87.2 %		
4/2 (Nine Mile Ride)	3.65	0.00	N	Arm 7 Right	30.00	100.0 %	2019	2019
4/3 (Nine Mile Ride)	3.65	0.00	N	Arm 7 Right	30.00	100.0 %	2019	2019
5/1	Infinite Saturation Flow						Inf	Inf
5/2	Infinite Saturation Flow						Inf	Inf
5/3	Infinite Saturation Flow						Inf	Inf
6/1	Infinite Saturation Flow						Inf	Inf
7/1	Infinite Saturation Flow						Inf	Inf
7/2	Infinite Saturation Flow						Inf	Inf
7/3	Infinite Saturation Flow						Inf	Inf
8/1	Infinite Saturation Flow						Inf	Inf
8/2	Infinite Saturation Flow						Inf	Inf

Scenario 5: '2013 AM 90%' (FG5: '2013 Observed AM 90%', Plan 1: 'Option1')

Traffic Flows, Desired

Desired Flow :

	Destination					Tot.
	A	B	C	D		
Origin						
A	2	61	1301	103	1467	
B	50	0	140	204	394	
C	1504	87	5	345	1941	
D	64	167	354	0	585	
Tot.	1620	315	1800	652	4387	

Traffic Lane Flows

Lane	Scenario 5: 2013 AM 90%
Junction: Coral Reef X Roads	
1/1	425
1/2	469
1/3	468
1/4	103
2/1	140
2/2	127
2/3	127
3/1	566
3/2	640
3/3	643
3/4	87
4/1	231
4/2	178
4/3	176
5/1	285
5/2	640
5/3	693
6/1	315
7/1	523
7/2	628
7/3	644
8/1	300
8/2	352

Lane Saturation Flows

Junction: Coral Reef X Roads								
Lane	Lane Width (m)	Gradient	Nearside Lane	Allowed Turns	Turning Radius (m)	Turning Prop.	Sat Flow (PCU/Hr)	Flared Sat Flow (PCU/Hr)
1/1 (A322 (Eastbound))	3.60	0.00	Y	Arm 6 Left	Inf	14.4 %	1975	1975
				Arm 7 Ahead	Inf	85.6 %		
1/2 (A322 (Eastbound))	3.60	0.00	N	Arm 7 Ahead	Inf	100.0 %	2115	2115
1/3 (A322 (Eastbound))	3.60	0.00	N	Arm 7 Ahead	Inf	100.0 %	2115	2115
1/4 (A322 (Eastbound))	3.60	0.00	N	Arm 8 Right	Inf	100.0 %	2115	2115
2/1 (New Forest Ride)	4.00	0.00	Y	Arm 7 Left	20.00	100.0 %	1874	1874
2/2 (New Forest Ride)	4.00	0.00	N	Arm 8 Ahead	Inf	100.0 %	2155	2155
2/3 (New Forest Ride)	4.00	0.00	N	Arm 5 Right	Inf	39.4 %	2155	2155
				Arm 8 Ahead	Inf	60.6 %		
3/1 (A322 (Westbound))	3.60	0.00	Y	Arm 5 Ahead	Inf	39.0 %	1917	1917
				Arm 8 Left	30.00	61.0 %		
3/2 (A322 (Westbound))	3.60	0.00	N	Arm 5 Ahead	Inf	100.0 %	2115	2115
3/3 (A322 (Westbound))	3.70	0.00	N	Arm 5 Ahead	Inf	100.0 %	2125	2125
3/4 (A322 (Westbound))	3.60	0.00	N	Arm 6 Right	Inf	100.0 %	2115	2115
4/1 (Nine Mile Ride)	3.65	0.00	N	Arm 5 Left	15.00	27.7 %	2063	2063
				Arm 6 Ahead	Inf	72.3 %		
4/2 (Nine Mile Ride)	3.65	0.00	N	Arm 7 Right	30.00	100.0 %	2019	2019
4/3 (Nine Mile Ride)	3.65	0.00	N	Arm 7 Right	30.00	100.0 %	2019	2019
5/1	Infinite Saturation Flow						Inf	Inf
5/2	Infinite Saturation Flow						Inf	Inf
5/3	Infinite Saturation Flow						Inf	Inf
6/1	Infinite Saturation Flow						Inf	Inf
7/1	Infinite Saturation Flow						Inf	Inf
7/2	Infinite Saturation Flow						Inf	Inf
7/3	Infinite Saturation Flow						Inf	Inf
8/1	Infinite Saturation Flow						Inf	Inf
8/2	Infinite Saturation Flow						Inf	Inf

Scenario 6: '2013 PM 90%' (FG6: '2013 Observed PM 90%', Plan 1: 'Option1')

Traffic Flows, Desired

Desired Flow :

	Destination					Tot.
	A	B	C	D		
A	5	77	1428	82	1592	
B	140	0	69	258	467	
C	1534	158	6	455	2153	
D	104	179	253	0	536	
Tot.	1783	414	1756	795	4748	

Traffic Lane Flows

Lane	Scenario 6: 2013 PM 90%
Junction: Coral Reef X Roads	
1/1	471
1/2	517
1/3	517
1/4	82
2/1	69
2/2	199
2/3	199
3/1	608
3/2	688
3/3	693
3/4	158
4/1	283
4/2	126
4/3	127
5/1	257
5/2	688
5/3	833
6/1	414
7/1	491
7/2	615
7/3	644
8/1	427
8/2	368

Lane Saturation Flows

Junction: Coral Reef X Roads								
Lane	Lane Width (m)	Gradient	Nearside Lane	Allowed Turns	Turning Radius (m)	Turning Prop.	Sat Flow (PCU/Hr)	Flared Sat Flow (PCU/Hr)
1/1 (A322 (Eastbound))	3.60	0.00	Y	Arm 6 Left	Inf	16.3 %	1975	1975
				Arm 7 Ahead	Inf	83.7 %		
1/2 (A322 (Eastbound))	3.60	0.00	N	Arm 7 Ahead	Inf	100.0 %	2115	2115
1/3 (A322 (Eastbound))	3.60	0.00	N	Arm 7 Ahead	Inf	100.0 %	2115	2115
1/4 (A322 (Eastbound))	3.60	0.00	N	Arm 8 Right	Inf	100.0 %	2115	2115
2/1 (New Forest Ride)	4.00	0.00	Y	Arm 7 Left	20.00	100.0 %	1874	1874
2/2 (New Forest Ride)	4.00	0.00	N	Arm 8 Ahead	Inf	100.0 %	2155	2155
2/3 (New Forest Ride)	4.00	0.00	N	Arm 5 Right	Inf	70.4 %	2155	2155
				Arm 8 Ahead	Inf	29.6 %		
3/1 (A322 (Westbound))	3.60	0.00	Y	Arm 5 Ahead	Inf	25.2 %	1904	1904
				Arm 8 Left	30.00	74.8 %		
3/2 (A322 (Westbound))	3.60	0.00	N	Arm 5 Ahead	Inf	100.0 %	2115	2115
3/3 (A322 (Westbound))	3.70	0.00	N	Arm 5 Ahead	Inf	100.0 %	2125	2125
3/4 (A322 (Westbound))	3.60	0.00	N	Arm 6 Right	Inf	100.0 %	2115	2115
4/1 (Nine Mile Ride)	3.65	0.00	N	Arm 5 Left	15.00	36.7 %	2045	2045
				Arm 6 Ahead	Inf	63.3 %		
4/2 (Nine Mile Ride)	3.65	0.00	N	Arm 7 Right	30.00	100.0 %	2019	2019
4/3 (Nine Mile Ride)	3.65	0.00	N	Arm 7 Right	30.00	100.0 %	2019	2019
5/1	Infinite Saturation Flow						Inf	Inf
5/2	Infinite Saturation Flow						Inf	Inf
5/3	Infinite Saturation Flow						Inf	Inf
6/1	Infinite Saturation Flow						Inf	Inf
7/1	Infinite Saturation Flow						Inf	Inf
7/2	Infinite Saturation Flow						Inf	Inf
7/3	Infinite Saturation Flow						Inf	Inf
8/1	Infinite Saturation Flow						Inf	Inf
8/2	Infinite Saturation Flow						Inf	Inf

Scenario 7: '2026 AM 90%' (FG7: '2026 M3 AM 90%', Plan 1: 'Option1')

Traffic Flows, Desired

Desired Flow :

	Destination					Tot.
	A	B	C	D		
Origin	A	0	15	1229	166	1410
	B	179	0	208	178	565
	C	1869	156	0	346	2371
	D	47	77	574	0	698
	Tot.	2095	248	2011	690	5044

Traffic Lane Flows

Lane	Scenario 7: 2026 AM 90%
Junction: Coral Reef X Roads	
1/1	388
1/2	428
1/3	428
1/4	166
2/1	208
2/2	178
2/3	179
3/1	685
3/2	763
3/3	767
3/4	156
4/1	124
4/2	286
4/3	288
5/1	386
5/2	763
5/3	946
6/1	248
7/1	620
7/2	675
7/3	716
8/1	351
8/2	339

Lane Saturation Flows

Junction: Coral Reef X Roads								
Lane	Lane Width (m)	Gradient	Nearside Lane	Allowed Turns	Turning Radius (m)	Turning Prop.	Sat Flow (PCU/Hr)	Flared Sat Flow (PCU/Hr)
1/1 (A322 (Eastbound))	3.60	0.00	Y	Arm 6 Left	Inf	3.9 %	1975	1975
				Arm 7 Ahead	Inf	96.1 %		
1/2 (A322 (Eastbound))	3.60	0.00	N	Arm 7 Ahead	Inf	100.0 %	2115	2115
1/3 (A322 (Eastbound))	3.60	0.00	N	Arm 7 Ahead	Inf	100.0 %	2115	2115
1/4 (A322 (Eastbound))	3.60	0.00	N	Arm 8 Right	Inf	100.0 %	2115	2115
2/1 (New Forest Ride)	4.00	0.00	Y	Arm 7 Left	20.00	100.0 %	1874	1874
2/2 (New Forest Ride)	4.00	0.00	N	Arm 8 Ahead	Inf	100.0 %	2155	2155
2/3 (New Forest Ride)	4.00	0.00	N	Arm 5 Right	Inf	100.0 %	2155	2155
				Arm 8 Ahead	Inf	0.0 %		
3/1 (A322 (Westbound))	3.60	0.00	Y	Arm 5 Ahead	Inf	49.5 %	1926	1926
				Arm 8 Left	30.00	50.5 %		
3/2 (A322 (Westbound))	3.60	0.00	N	Arm 5 Ahead	Inf	100.0 %	2115	2115
3/3 (A322 (Westbound))	3.70	0.00	N	Arm 5 Ahead	Inf	100.0 %	2125	2125
3/4 (A322 (Westbound))	3.60	0.00	N	Arm 6 Right	Inf	100.0 %	2115	2115
4/1 (Nine Mile Ride)	3.65	0.00	N	Arm 5 Left	15.00	37.9 %	2043	2043
				Arm 6 Ahead	Inf	62.1 %		
4/2 (Nine Mile Ride)	3.65	0.00	N	Arm 7 Right	30.00	100.0 %	2019	2019
4/3 (Nine Mile Ride)	3.65	0.00	N	Arm 7 Right	30.00	100.0 %	2019	2019
5/1	Infinite Saturation Flow						Inf	Inf
5/2	Infinite Saturation Flow						Inf	Inf
5/3	Infinite Saturation Flow						Inf	Inf
6/1	Infinite Saturation Flow						Inf	Inf
7/1	Infinite Saturation Flow						Inf	Inf
7/2	Infinite Saturation Flow						Inf	Inf
7/3	Infinite Saturation Flow						Inf	Inf
8/1	Infinite Saturation Flow						Inf	Inf
8/2	Infinite Saturation Flow						Inf	Inf

Scenario 8: '2026 PM 90%' (FG8: '2026 M3 PM 90%', Plan 1: 'Option1')

Traffic Flows, Desired

Desired Flow :

	Destination					Tot.
	A	B	C	D		
Origin						
A	0	1	1689	67	1757	
B	24	0	259	590	873	
C	1751	77	0	308	2136	
D	36	245	230	0	511	
Tot.	1811	323	2178	965	5277	

Traffic Lane Flows

Lane	Scenario 8: 2026 PM 90%
Junction: Coral Reef X Roads	
1/1	531
1/2	580
1/3	579
1/4	67
2/1	259
2/2	307
2/3	307
3/1	639
3/2	708
3/3	712
3/4	77
4/1	281
4/2	116
4/3	114
5/1	367
5/2	708
5/3	736
6/1	323
7/1	717
7/2	768
7/3	693
8/1	461
8/2	504

Lane Saturation Flows

Junction: Coral Reef X Roads								
Lane	Lane Width (m)	Gradient	Nearside Lane	Allowed Turns	Turning Radius (m)	Turning Prop.	Sat Flow (PCU/Hr)	Flared Sat Flow (PCU/Hr)
1/1 (A322 (Eastbound))	3.60	0.00	Y	Arm 6 Left	Inf	0.2 %	1975	1975
				Arm 7 Ahead	Inf	99.8 %		
1/2 (A322 (Eastbound))	3.60	0.00	N	Arm 7 Ahead	Inf	100.0 %	2115	2115
1/3 (A322 (Eastbound))	3.60	0.00	N	Arm 7 Ahead	Inf	100.0 %	2115	2115
1/4 (A322 (Eastbound))	3.60	0.00	N	Arm 8 Right	Inf	100.0 %	2115	2115
2/1 (New Forest Ride)	4.00	0.00	Y	Arm 7 Left	20.00	100.0 %	1874	1874
2/2 (New Forest Ride)	4.00	0.00	N	Arm 8 Ahead	Inf	100.0 %	2155	2155
2/3 (New Forest Ride)	4.00	0.00	N	Arm 5 Right	Inf	7.8 %	2155	2155
				Arm 8 Ahead	Inf	92.2 %		
3/1 (A322 (Westbound))	3.60	0.00	Y	Arm 5 Ahead	Inf	51.8 %	1929	1929
				Arm 8 Left	30.00	48.2 %		
3/2 (A322 (Westbound))	3.60	0.00	N	Arm 5 Ahead	Inf	100.0 %	2115	2115
3/3 (A322 (Westbound))	3.70	0.00	N	Arm 5 Ahead	Inf	100.0 %	2125	2125
3/4 (A322 (Westbound))	3.60	0.00	N	Arm 6 Right	Inf	100.0 %	2115	2115
4/1 (Nine Mile Ride)	3.65	0.00	N	Arm 5 Left	15.00	12.8 %	2093	2093
				Arm 6 Ahead	Inf	87.2 %		
4/2 (Nine Mile Ride)	3.65	0.00	N	Arm 7 Right	30.00	100.0 %	2019	2019
4/3 (Nine Mile Ride)	3.65	0.00	N	Arm 7 Right	30.00	100.0 %	2019	2019
5/1	Infinite Saturation Flow						Inf	Inf
5/2	Infinite Saturation Flow						Inf	Inf
5/3	Infinite Saturation Flow						Inf	Inf
6/1	Infinite Saturation Flow						Inf	Inf
7/1	Infinite Saturation Flow						Inf	Inf
7/2	Infinite Saturation Flow						Inf	Inf
7/3	Infinite Saturation Flow						Inf	Inf
8/1	Infinite Saturation Flow						Inf	Inf
8/2	Infinite Saturation Flow						Inf	Inf

Scenario 1: '2013 AM Peak' (FG1: '2013 Observed AM', Plan 3: 'Option 3')

Stage Sequence Diagram

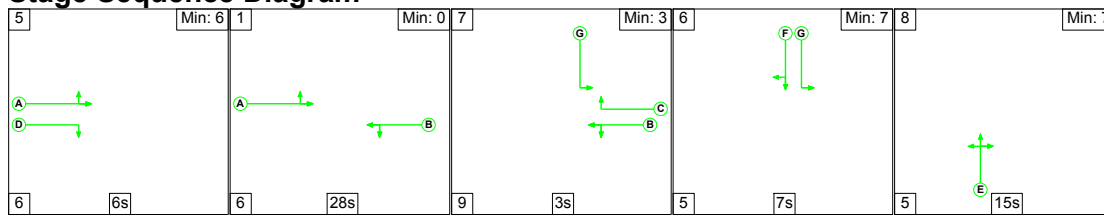

Stage Timings

Stage	5	1	7	6	8
Duration	6	28	3	7	15
Change Point	0	12	46	58	70

Signal Timings Diagram

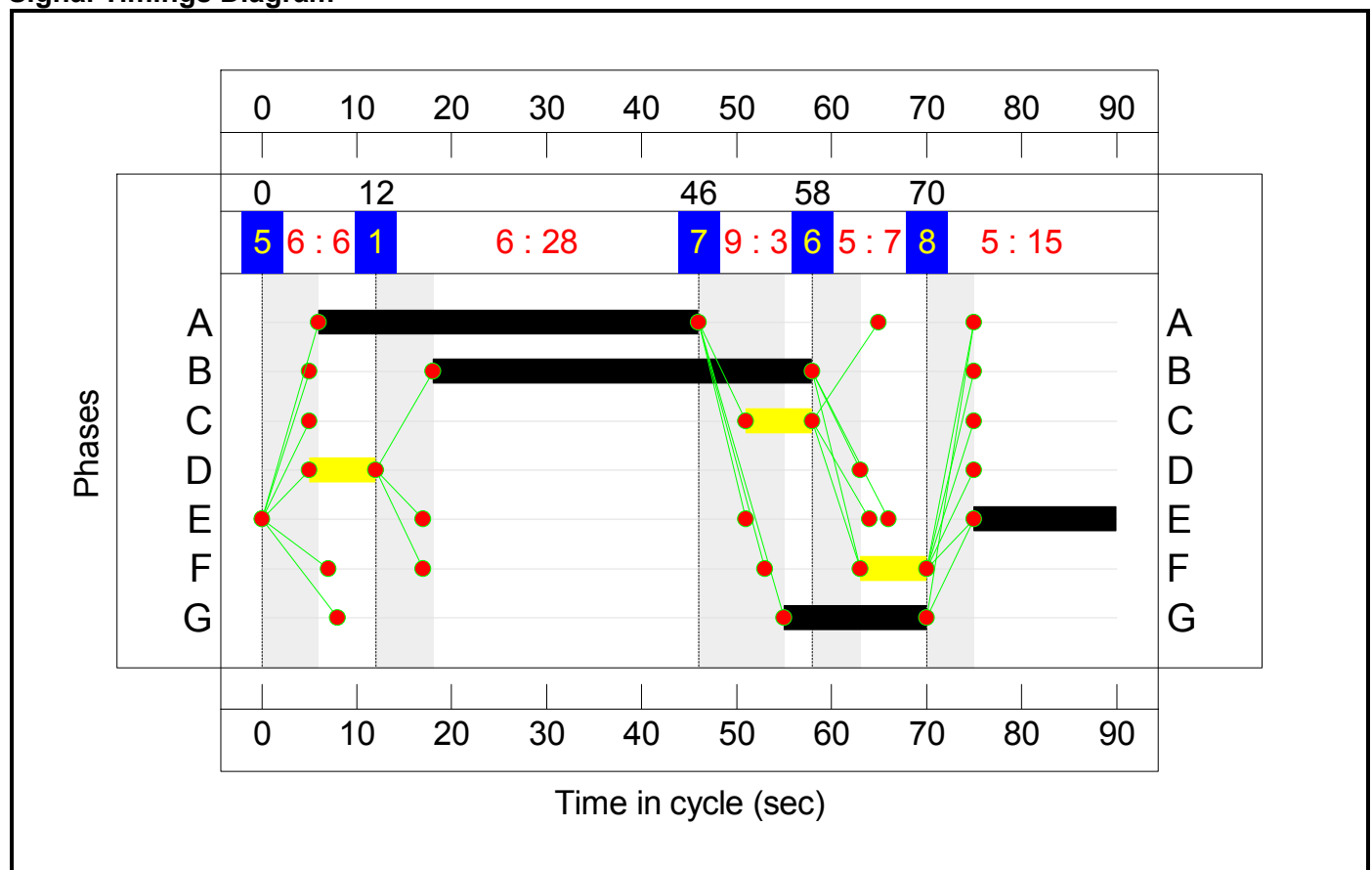

Network Layout Diagram

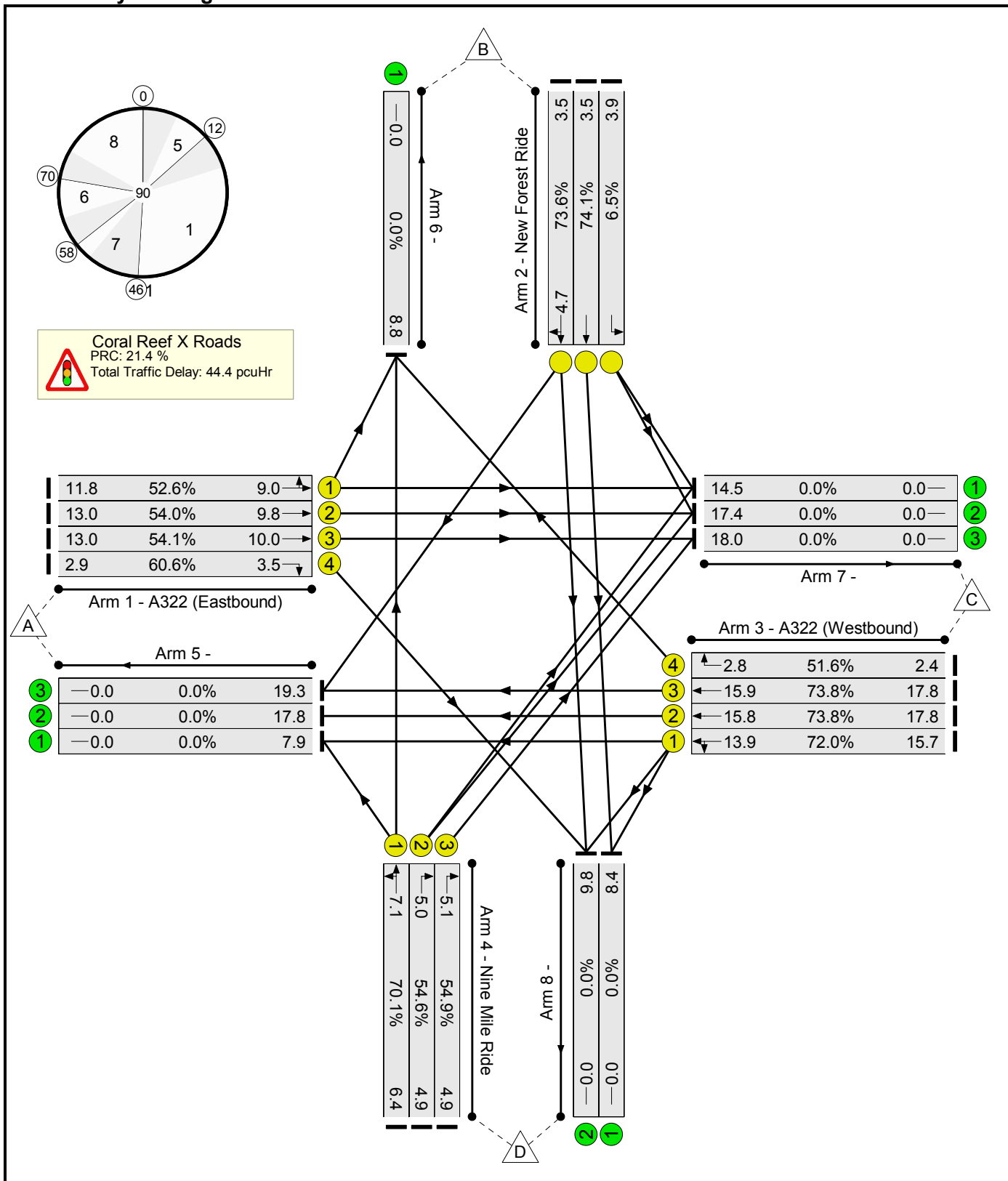

Full Input Data And Results
CR Final Layout 20140707.lsg3x

Network Results

Item	Lane Description	Lane Type	Controller Stream	Position In Filtered Route	Full Phase	Arrow Phase	Num Greens	Total Green (s)	Arrow Green (s)	Demand Flow (pcu)	Sat Flow (pcu/Hr)	Capacity (pcu)	Deg Sat (%)
Network: Proposed Crossroads	-	-	N/A	-	-		-	-	-	-	-	-	74.1%
Coral Reef X Roads	-	-	N/A	-	-		-	-	-	-	-	-	74.1%
1/1	A322 (Eastbound) Left Ahead	U	N/A	N/A	A		1	40	-	473	1975	900	52.6%
1/2	A322 (Eastbound) Ahead	U	N/A	N/A	A		1	40	-	520	2115	964	54.0%
1/3	A322 (Eastbound) Ahead	U	N/A	N/A	A		1	40	-	521	2115	964	54.1%
1/4	A322 (Eastbound) Right	U	N/A	N/A	D		1	7	-	114	2115	188	60.6%
2/1	New Forest Ride Left	U	N/A	N/A	G		1	15	-	155	1874	333	46.5%
2/2	New Forest Ride Ahead	U	N/A	N/A	F		1	7	-	142	2155	192	74.1%
2/3	New Forest Ride Right Ahead	U	N/A	N/A	F		1	7	-	141	2155	192	73.6%
3/1	A322 (Westbound) Ahead Left	U	N/A	N/A	B		1	40	-	629	1917	873	72.0%
3/2	A322 (Westbound) Ahead	U	N/A	N/A	B		1	40	-	711	2115	964	73.8%
3/3	A322 (Westbound) Ahead	U	N/A	N/A	B		1	40	-	714	2125	968	73.8%
3/4	A322 (Westbound) Right	U	N/A	N/A	C		1	7	-	97	2115	188	51.6%
4/1	Nine Mile Ride Left Ahead	U	N/A	N/A	E		1	15	-	257	2063	367	70.1%

Full Input Data And Results
 CR Final Layout 20140707.lsg3x

4/2	Nine Mile Ride Right	U	N/A	N/A	E		1	15	-	196	2019	359	54.6%
4/3	Nine Mile Ride Right	U	N/A	N/A	E		1	15	-	197	2019	359	54.9%
5/1		U	N/A	N/A	-		-	-	-	317	Inf	Inf	0.0%
5/2		U	N/A	N/A	-		-	-	-	711	Inf	Inf	0.0%
5/3		U	N/A	N/A	-		-	-	-	770	Inf	Inf	0.0%
6/1		U	N/A	N/A	-		-	-	-	351	Inf	Inf	0.0%
7/1		U	N/A	N/A	-		-	-	-	580	Inf	Inf	0.0%
7/2		U	N/A	N/A	-		-	-	-	696	Inf	Inf	0.0%
7/3		U	N/A	N/A	-		-	-	-	718	Inf	Inf	0.0%
8/1		U	N/A	N/A	-		-	-	-	334	Inf	Inf	0.0%
8/2		U	N/A	N/A	-		-	-	-	390	Inf	Inf	0.0%

Full Input Data And Results
CR Final Layout 20140707.lsg3x

Item	Arriving (pcu)	Leaving (pcu)	Turners In Gaps (pcu)	Turners When Unopposed (pcu)	Turners In Intergreen (pcu)	Uniform Delay (pcuHr)	Rand + Oversat Delay (pcuHr)	Storage Area Uniform Delay (pcuHr)	Total Delay (pcuHr)	Av. Delay Per PCU (s/pcu)	Max. Back of Uniform Queue (pcu)	Rand + Oversat Queue (pcu)	Mean Max Queue (pcu)
Network: Proposed Crossroads	-	-	0	0	0	31.9	12.5	0.0	44.4	-	-	-	-
Coral Reef X Roads	-	-	0	0	0	31.9	12.5	0.0	44.4	-	-	-	-
1/1	473	473	-	-	-	2.3	0.6	-	2.9	21.8	8.4	0.6	9.0
1/2	520	520	-	-	-	2.6	0.6	-	3.1	21.7	9.2	0.6	9.8
1/3	521	521	-	-	-	2.6	0.6	-	3.1	21.8	9.4	0.6	10.0
1/4	114	114	-	-	-	1.3	0.8	-	2.0	63.3	2.7	0.8	3.5
2/1	155	155	-	-	-	1.4	0.4	-	1.9	43.2	3.4	0.4	3.9
2/2	142	142	-	-	-	1.6	1.4	-	2.9	74.4	3.4	1.4	4.8
2/3	141	141	-	-	-	1.6	1.3	-	2.9	73.8	3.4	1.3	4.7
3/1	629	629	-	-	-	3.5	1.3	-	4.7	27.1	12.6	1.3	13.9
3/2	711	711	-	-	-	4.0	1.4	-	5.4	27.1	14.4	1.4	15.8
3/3	714	714	-	-	-	4.0	1.4	-	5.4	27.1	14.5	1.4	15.9
3/4	97	97	-	-	-	1.1	0.5	-	1.6	58.7	2.3	0.5	2.8
4/1	257	257	-	-	-	2.5	1.1	-	3.6	50.8	6.0	1.1	7.1
4/2	196	196	-	-	-	1.8	0.6	-	2.4	44.7	4.4	0.6	5.0
4/3	197	197	-	-	-	1.8	0.6	-	2.4	44.7	4.5	0.6	5.1
5/1	317	317	-	-	-	0.0	0.0	-	0.0	0.0	0.0	0.0	0.0
5/2	711	711	-	-	-	0.0	0.0	-	0.0	0.0	0.0	0.0	0.0
5/3	770	770	-	-	-	0.0	0.0	-	0.0	0.0	0.0	0.0	0.0
6/1	351	351	-	-	-	0.0	0.0	-	0.0	0.0	0.0	0.0	0.0
7/1	580	580	-	-	-	0.0	0.0	-	0.0	0.0	0.0	0.0	0.0
7/2	696	696	-	-	-	0.0	0.0	-	0.0	0.0	0.0	0.0	0.0
7/3	718	718	-	-	-	0.0	0.0	-	0.0	0.0	0.0	0.0	0.0
8/1	334	334	-	-	-	0.0	0.0	-	0.0	0.0	0.0	0.0	0.0
8/2	390	390	-	-	-	0.0	0.0	-	0.0	0.0	0.0	0.0	0.0

Full Input Data And Results
CR Final Layout 20140707.lsg3x

C1	PRC for Signalled Lanes (%):	21.4	Total Delay for Signalled Lanes (pcuHr):	44.41	Cycle Time (s):	90
	PRC Over All Lanes (%):	21.4	Total Delay Over All Lanes(pcuHr):	44.41		

Stage Sequence Diagram

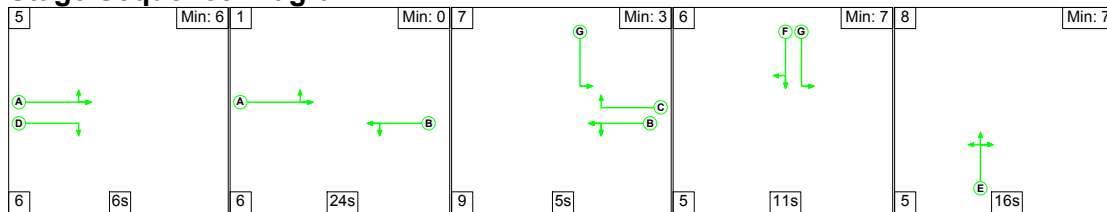

Stage Timings

Stage	5	1	7	6	8
Duration	6	24	5	11	16
Change Point	0	12	42	56	72

Signal Timings Diagram

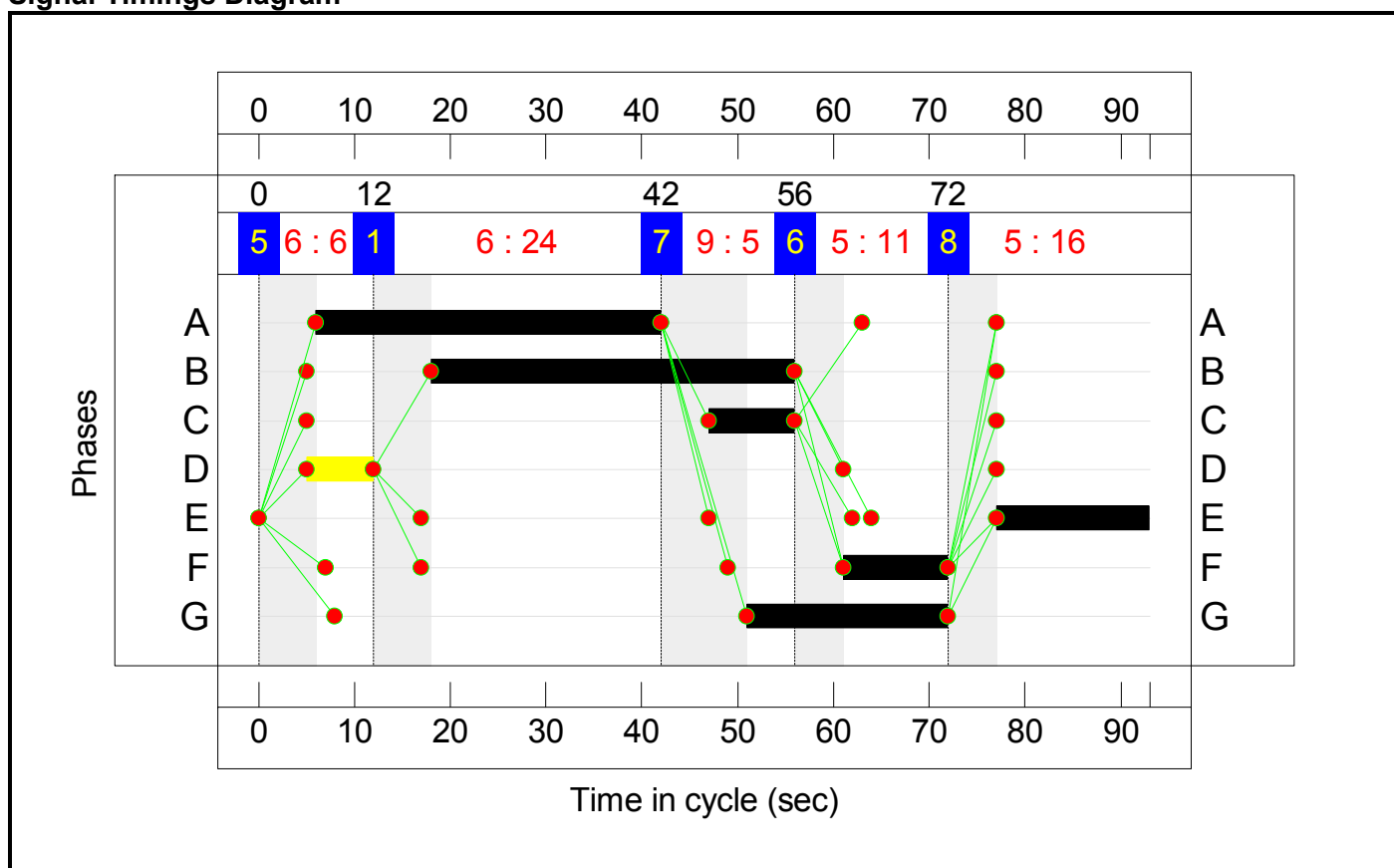

Network Layout Diagram

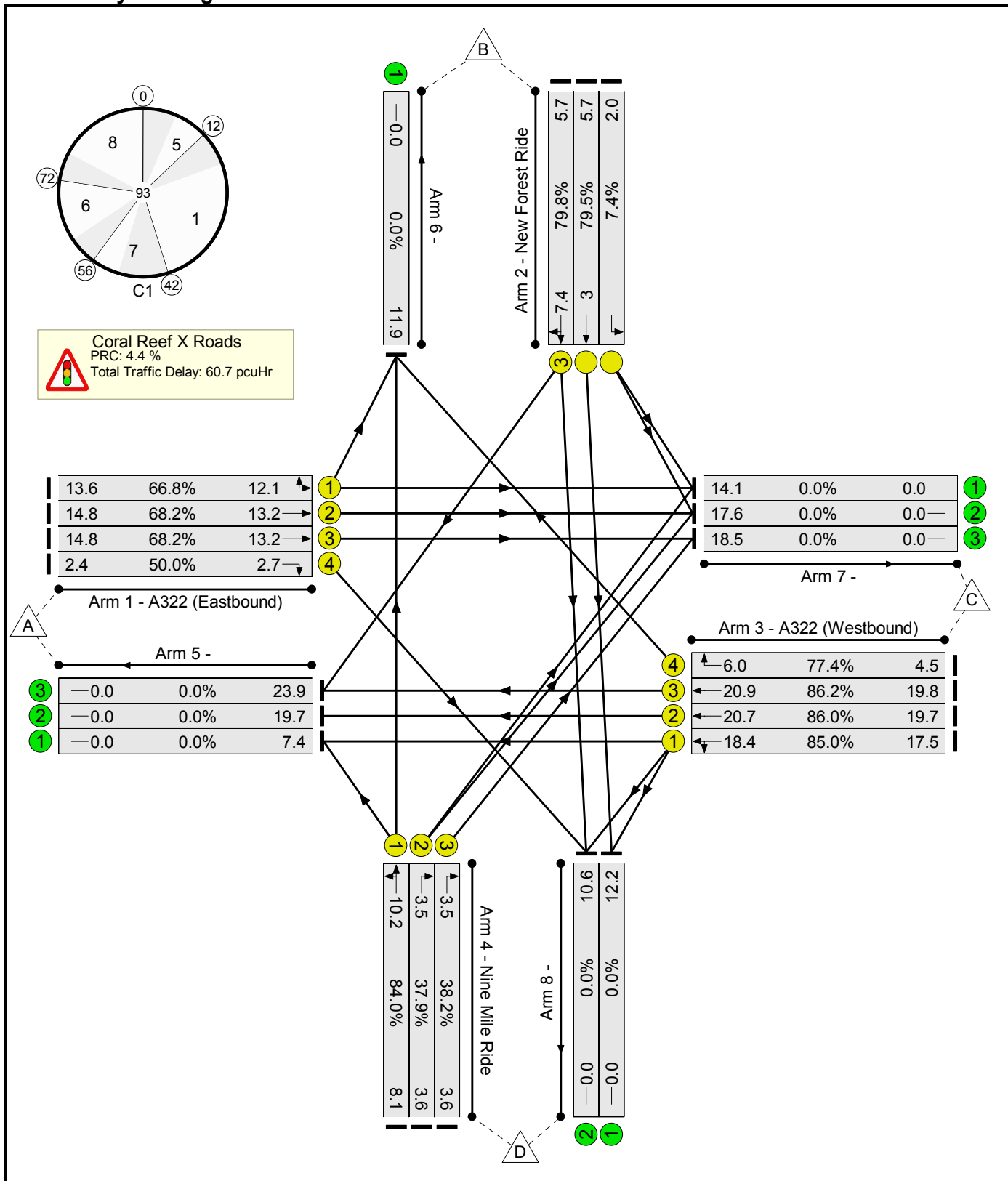

Full Input Data And Results
CR Final Layout 20140707.lsg3x

Network Results

Item	Lane Description	Lane Type	Controller Stream	Position In Filtered Route	Full Phase	Arrow Phase	Num Greens	Total Green (s)	Arrow Green (s)	Demand Flow (pcu)	Sat Flow (pcu/Hr)	Capacity (pcu)	Deg Sat (%)
Network: Proposed Crossroads	-	-	N/A	-	-		-	-	-	-	-	-	86.2%
Coral Reef X Roads	-	-	N/A	-	-		-	-	-	-	-	-	86.2%
1/1	A322 (Eastbound) Left Ahead	U	N/A	N/A	A		1	36	-	525	1975	786	66.8%
1/2	A322 (Eastbound) Ahead	U	N/A	N/A	A		1	36	-	574	2115	841	68.2%
1/3	A322 (Eastbound) Ahead	U	N/A	N/A	A		1	36	-	574	2115	841	68.2%
1/4	A322 (Eastbound) Right	U	N/A	N/A	D		1	7	-	91	2115	182	50.0%
2/1	New Forest Ride Left	U	N/A	N/A	G		1	21	-	77	1874	443	17.4%
2/2	New Forest Ride Ahead	U	N/A	N/A	F		1	11	-	221	2155	278	79.5%
2/3	New Forest Ride Right Ahead	U	N/A	N/A	F		1	11	-	222	2155	278	79.8%
3/1	A322 (Westbound) Ahead Left	U	N/A	N/A	B		1	38	-	679	1904	798	85.0%
3/2	A322 (Westbound) Ahead	U	N/A	N/A	B		1	38	-	763	2115	887	86.0%
3/3	A322 (Westbound) Ahead	U	N/A	N/A	B		1	38	-	768	2125	891	86.2%
3/4	A322 (Westbound) Right	U	N/A	N/A	C		1	9	-	176	2115	227	77.4%
4/1	Nine Mile Ride Left Ahead	U	N/A	N/A	E		1	16	-	314	2045	374	84.0%

Full Input Data And Results
 CR Final Layout 20140707.lsg3x

4/2	Nine Mile Ride Right	U	N/A	N/A	E		1	16	-	140	2019	369	37.9%
4/3	Nine Mile Ride Right	U	N/A	N/A	E		1	16	-	141	2019	369	38.2%
5/1		U	N/A	N/A	-		-	-	-	288	Inf	Inf	0.0%
5/2		U	N/A	N/A	-		-	-	-	763	Inf	Inf	0.0%
5/3		U	N/A	N/A	-		-	-	-	924	Inf	Inf	0.0%
6/1		U	N/A	N/A	-		-	-	-	461	Inf	Inf	0.0%
7/1		U	N/A	N/A	-		-	-	-	547	Inf	Inf	0.0%
7/2		U	N/A	N/A	-		-	-	-	683	Inf	Inf	0.0%
7/3		U	N/A	N/A	-		-	-	-	715	Inf	Inf	0.0%
8/1		U	N/A	N/A	-		-	-	-	474	Inf	Inf	0.0%
8/2		U	N/A	N/A	-		-	-	-	410	Inf	Inf	0.0%

Full Input Data And Results
CR Final Layout 20140707.lsg3x

Item	Arriving (pcu)	Leaving (pcu)	Turners In Gaps (pcu)	Turners When Unopposed (pcu)	Turners In Intergreen (pcu)	Uniform Delay (pcuHr)	Rand + Oversat Delay (pcuHr)	Storage Area Uniform Delay (pcuHr)	Total Delay (pcuHr)	Av. Delay Per PCU (s/pcu)	Max. Back of Uniform Queue (pcu)	Rand + Oversat Queue (pcu)	Mean Max Queue (pcu)
Network: Proposed Crossroads	-	-	0	0	0	40.0	20.7	0.0	60.7	-	-	-	-
Coral Reef X Roads	-	-	0	0	0	40.0	20.7	0.0	60.7	-	-	-	-
1/1	525	525	-	-	-	3.3	1.0	-	4.3	29.8	11.1	1.0	12.1
1/2	574	574	-	-	-	3.7	1.1	-	4.8	29.8	12.1	1.1	13.2
1/3	574	574	-	-	-	3.7	1.1	-	4.8	29.8	12.1	1.1	13.2
1/4	91	91	-	-	-	1.0	0.5	-	1.5	60.2	2.2	0.5	2.7
2/1	77	77	-	-	-	0.6	0.1	-	0.7	33.2	1.6	0.1	1.7
2/2	221	221	-	-	-	2.4	1.8	-	4.2	69.0	5.5	1.8	7.3
2/3	222	222	-	-	-	2.4	1.9	-	4.3	69.4	5.6	1.9	7.4
3/1	679	679	-	-	-	4.6	2.7	-	7.3	38.8	15.7	2.7	18.4
3/2	763	763	-	-	-	5.2	2.9	-	8.1	38.4	17.8	2.9	20.7
3/3	768	768	-	-	-	5.2	3.0	-	8.2	38.5	17.9	3.0	20.9
3/4	176	176	-	-	-	2.0	1.6	-	3.6	73.4	4.4	1.6	6.0
4/1	314	314	-	-	-	3.2	2.4	-	5.6	64.5	7.8	2.4	10.2
4/2	140	140	-	-	-	1.3	0.3	-	1.6	41.2	3.2	0.3	3.5
4/3	141	141	-	-	-	1.3	0.3	-	1.6	41.3	3.2	0.3	3.5
5/1	288	288	-	-	-	0.0	0.0	-	0.0	0.0	0.0	0.0	0.0
5/2	763	763	-	-	-	0.0	0.0	-	0.0	0.0	0.0	0.0	0.0
5/3	924	924	-	-	-	0.0	0.0	-	0.0	0.0	0.0	0.0	0.0
6/1	461	461	-	-	-	0.0	0.0	-	0.0	0.0	0.0	0.0	0.0
7/1	547	547	-	-	-	0.0	0.0	-	0.0	0.0	0.0	0.0	0.0
7/2	683	683	-	-	-	0.0	0.0	-	0.0	0.0	0.0	0.0	0.0
7/3	715	715	-	-	-	0.0	0.0	-	0.0	0.0	0.0	0.0	0.0
8/1	474	474	-	-	-	0.0	0.0	-	0.0	0.0	0.0	0.0	0.0
8/2	410	410	-	-	-	0.0	0.0	-	0.0	0.0	0.0	0.0	0.0

Full Input Data And Results
CR Final Layout 20140707.lsg3x

C1	PRC for Signalled Lanes (%):	4.4	Total Delay for Signalled Lanes (pcuHr):	60.70	Cycle Time (s):	93
	PRC Over All Lanes (%):	4.4	Total Delay Over All Lanes(pcuHr):	60.70		

Stage Sequence Diagram

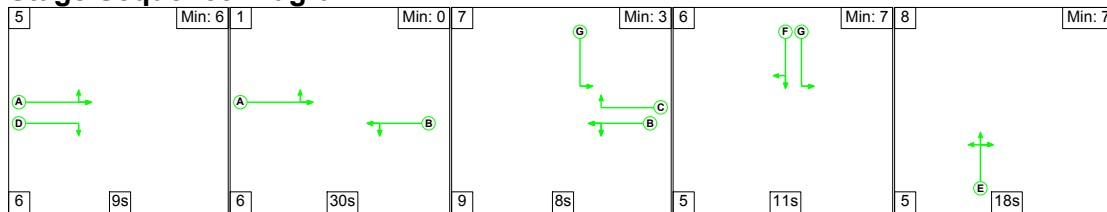

Stage Timings

Stage	5	1	7	6	8
Duration	9	30	8	11	18
Change Point	0	15	51	68	84

Signal Timings Diagram

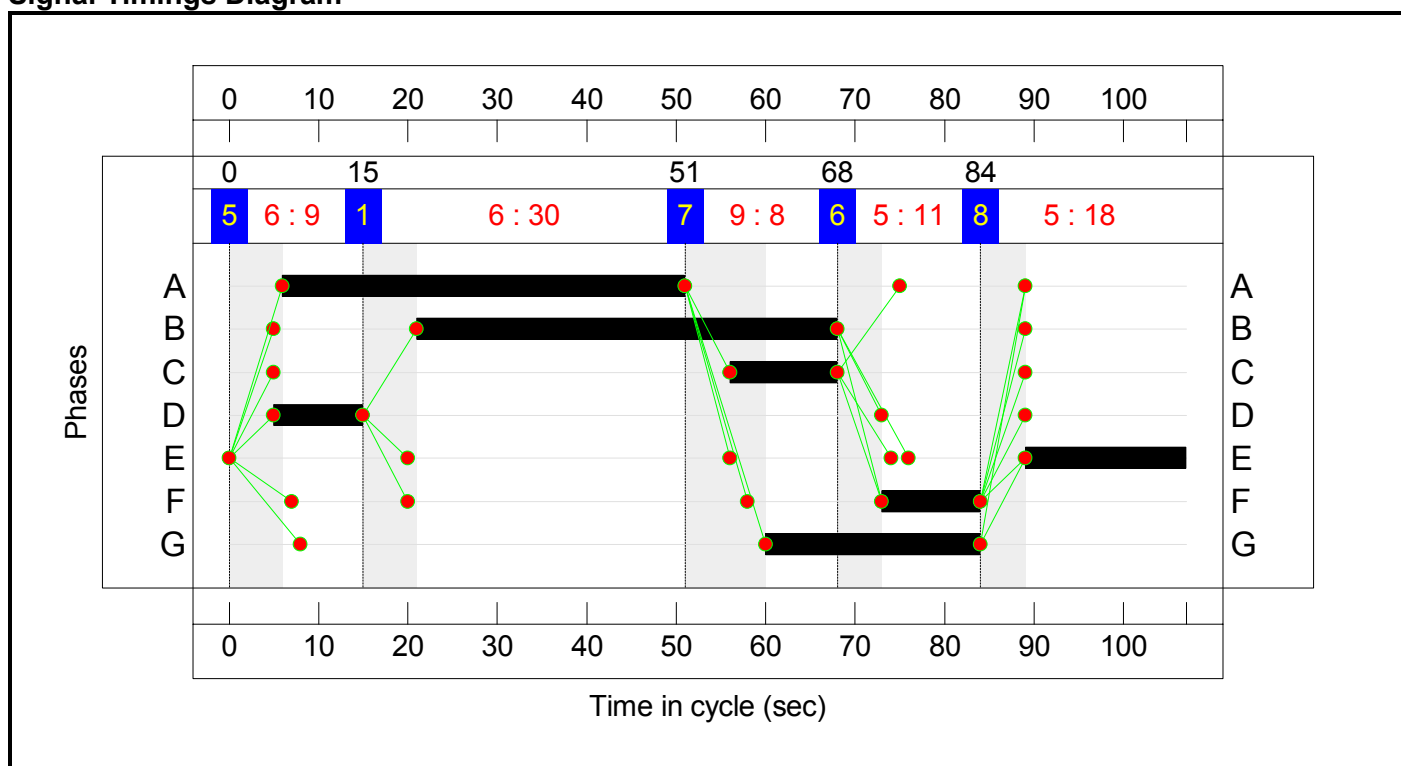

Network Layout Diagram

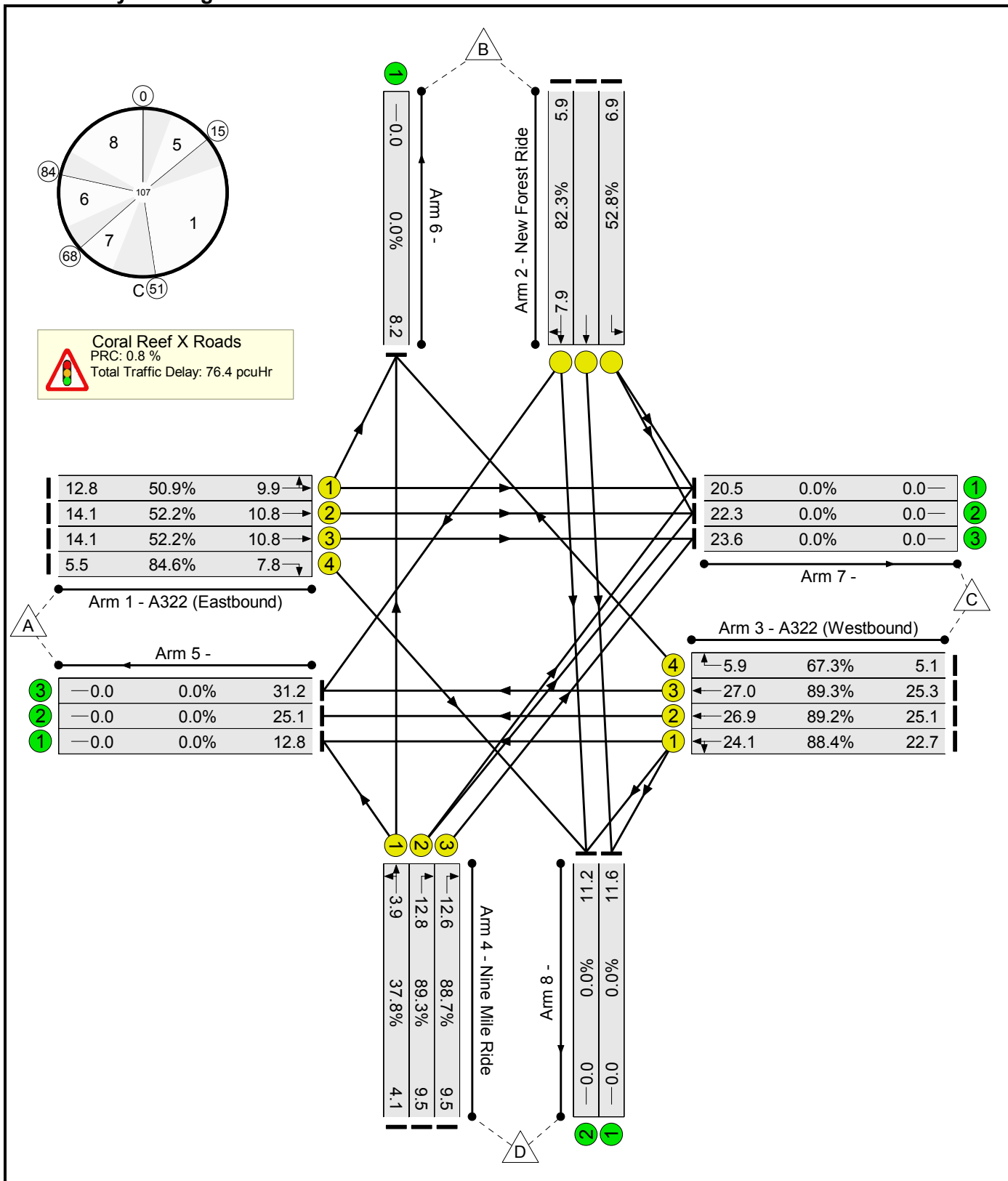

Full Input Data And Results
CR Final Layout 20140707.lsg3x

Network Results

Item	Lane Description	Lane Type	Controller Stream	Position In Filtered Route	Full Phase	Arrow Phase	Num Greens	Total Green (s)	Arrow Green (s)	Demand Flow (pcu)	Sat Flow (pcu/Hr)	Capacity (pcu)	Deg Sat (%)
Network: Proposed Crossroads	-	-	N/A	-	-		-	-	-	-	-	-	89.3%
Coral Reef X Roads	-	-	N/A	-	-		-	-	-	-	-	-	89.3%
1/1	A322 (Eastbound) Left Ahead	U	N/A	N/A	A		1	45	-	432	1975	849	50.9%
1/2	A322 (Eastbound) Ahead	U	N/A	N/A	A		1	45	-	475	2115	909	52.2%
1/3	A322 (Eastbound) Ahead	U	N/A	N/A	A		1	45	-	475	2115	909	52.2%
1/4	A322 (Eastbound) Right	U	N/A	N/A	D		1	10	-	184	2115	217	84.6%
2/1	New Forest Ride Left	U	N/A	N/A	G		1	24	-	231	1874	438	52.8%
2/2	New Forest Ride Ahead	U	N/A	N/A	F		1	11	-	198	2155	242	81.9%
2/3	New Forest Ride Right Ahead	U	N/A	N/A	F		1	11	-	199	2155	242	82.3%
3/1	A322 (Westbound) Ahead Left	U	N/A	N/A	B		1	47	-	764	1927	864	88.4%
3/2	A322 (Westbound) Ahead	U	N/A	N/A	B		1	47	-	846	2115	949	89.2%
3/3	A322 (Westbound) Ahead	U	N/A	N/A	B		1	47	-	851	2125	953	89.3%
3/4	A322 (Westbound) Right	U	N/A	N/A	C		1	12	-	173	2115	257	67.3%
4/1	Nine Mile Ride Left Ahead	U	N/A	N/A	E		1	18	-	137	2042	363	37.8%

Full Input Data And Results
 CR Final Layout 20140707.lsg3x

4/2	Nine Mile Ride Right	U	N/A	N/A	E		1	18	-	320	2019	359	89.3%
4/3	Nine Mile Ride Right	U	N/A	N/A	E		1	18	-	318	2019	359	88.7%
5/1		U	N/A	N/A	-		-	-	-	432	Inf	Inf	0.0%
5/2		U	N/A	N/A	-		-	-	-	846	Inf	Inf	0.0%
5/3		U	N/A	N/A	-		-	-	-	1050	Inf	Inf	0.0%
6/1		U	N/A	N/A	-		-	-	-	275	Inf	Inf	0.0%
7/1		U	N/A	N/A	-		-	-	-	690	Inf	Inf	0.0%
7/2		U	N/A	N/A	-		-	-	-	751	Inf	Inf	0.0%
7/3		U	N/A	N/A	-		-	-	-	793	Inf	Inf	0.0%
8/1		U	N/A	N/A	-		-	-	-	390	Inf	Inf	0.0%
8/2		U	N/A	N/A	-		-	-	-	376	Inf	Inf	0.0%

Full Input Data And Results
CR Final Layout 20140707.lsg3x

Item	Arriving (pcu)	Leaving (pcu)	Turners In Gaps (pcu)	Turners When Unopposed (pcu)	Turners In Intergreen (pcu)	Uniform Delay (pcuHr)	Rand + Oversat Delay (pcuHr)	Storage Area Uniform Delay (pcuHr)	Total Delay (pcuHr)	Av. Delay Per PCU (s/pcu)	Max. Back of Uniform Queue (pcu)	Rand + Oversat Queue (pcu)	Mean Max Queue (pcu)
Network: Proposed Crossroads	-	-	0	0	0	48.2	28.2	0.0	76.4	-	-	-	-
Coral Reef X Roads	-	-	0	0	0	48.2	28.2	0.0	76.4	-	-	-	-
1/1	432	432	-	-	-	2.7	0.5	-	3.2	26.6	9.4	0.5	9.9
1/2	475	475	-	-	-	3.0	0.5	-	3.5	26.6	10.3	0.5	10.8
1/3	475	475	-	-	-	3.0	0.5	-	3.5	26.6	10.3	0.5	10.8
1/4	184	184	-	-	-	2.4	2.4	-	4.8	94.2	5.4	2.4	7.8
2/1	231	231	-	-	-	2.3	0.6	-	2.9	44.5	6.0	0.6	6.5
2/2	198	198	-	-	-	2.6	2.1	-	4.6	84.1	5.7	2.1	7.8
2/3	199	199	-	-	-	2.6	2.1	-	4.7	84.8	5.7	2.1	7.9
3/1	764	764	-	-	-	5.7	3.6	-	9.3	43.7	20.6	3.6	24.1
3/2	846	846	-	-	-	6.4	3.8	-	10.2	43.4	23.0	3.8	26.9
3/3	851	851	-	-	-	6.4	3.9	-	10.3	43.5	23.2	3.9	27.0
3/4	173	173	-	-	-	2.2	1.0	-	3.2	65.9	4.9	1.0	5.9
4/1	137	137	-	-	-	1.5	0.3	-	1.8	46.8	3.6	0.3	3.9
4/2	320	320	-	-	-	3.8	3.5	-	7.3	82.5	9.2	3.5	12.8
4/3	318	318	-	-	-	3.8	3.4	-	7.2	81.1	9.2	3.4	12.6
5/1	432	432	-	-	-	0.0	0.0	-	0.0	0.0	0.0	0.0	0.0
5/2	846	846	-	-	-	0.0	0.0	-	0.0	0.0	0.0	0.0	0.0
5/3	1050	1050	-	-	-	0.0	0.0	-	0.0	0.0	0.0	0.0	0.0
6/1	275	275	-	-	-	0.0	0.0	-	0.0	0.0	0.0	0.0	0.0
7/1	690	690	-	-	-	0.0	0.0	-	0.0	0.0	0.0	0.0	0.0
7/2	751	751	-	-	-	0.0	0.0	-	0.0	0.0	0.0	0.0	0.0
7/3	793	793	-	-	-	0.0	0.0	-	0.0	0.0	0.0	0.0	0.0
8/1	390	390	-	-	-	0.0	0.0	-	0.0	0.0	0.0	0.0	0.0
8/2	376	376	-	-	-	0.0	0.0	-	0.0	0.0	0.0	0.0	0.0

Full Input Data And Results
CR Final Layout 20140707.lsg3x

C1	PRC for Signalled Lanes (%):	0.8	Total Delay for Signalled Lanes (pcuHr):	76.38	Cycle Time (s):	107
	PRC Over All Lanes (%):	0.8	Total Delay Over All Lanes(pcuHr):	76.38		

Full Input Data And Results
 CR Final Layout 20140707.lsg3x
Scenario 4: '2026 M3 PM' (FG4: '2026 M3 PM', Plan 3: 'Option 3')

Stage Sequence Diagram

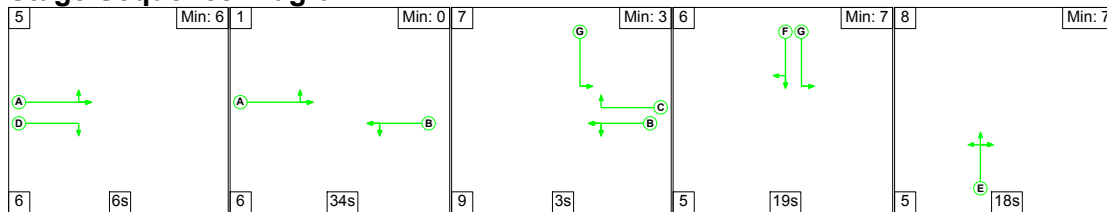

Stage Timings

Stage	5	1	7	6	8
Duration	6	34	3	19	18
Change Point	0	12	52	64	88

Signal Timings Diagram

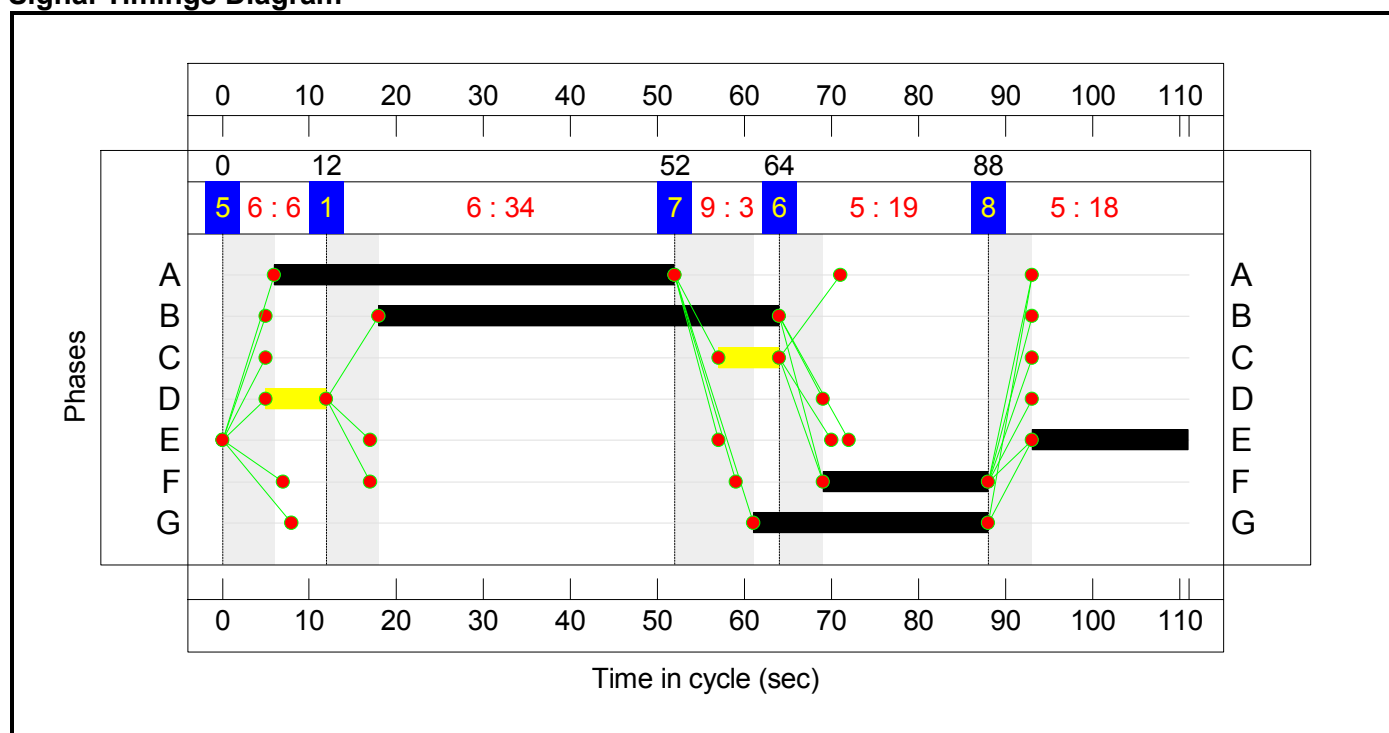

Network Layout Diagram

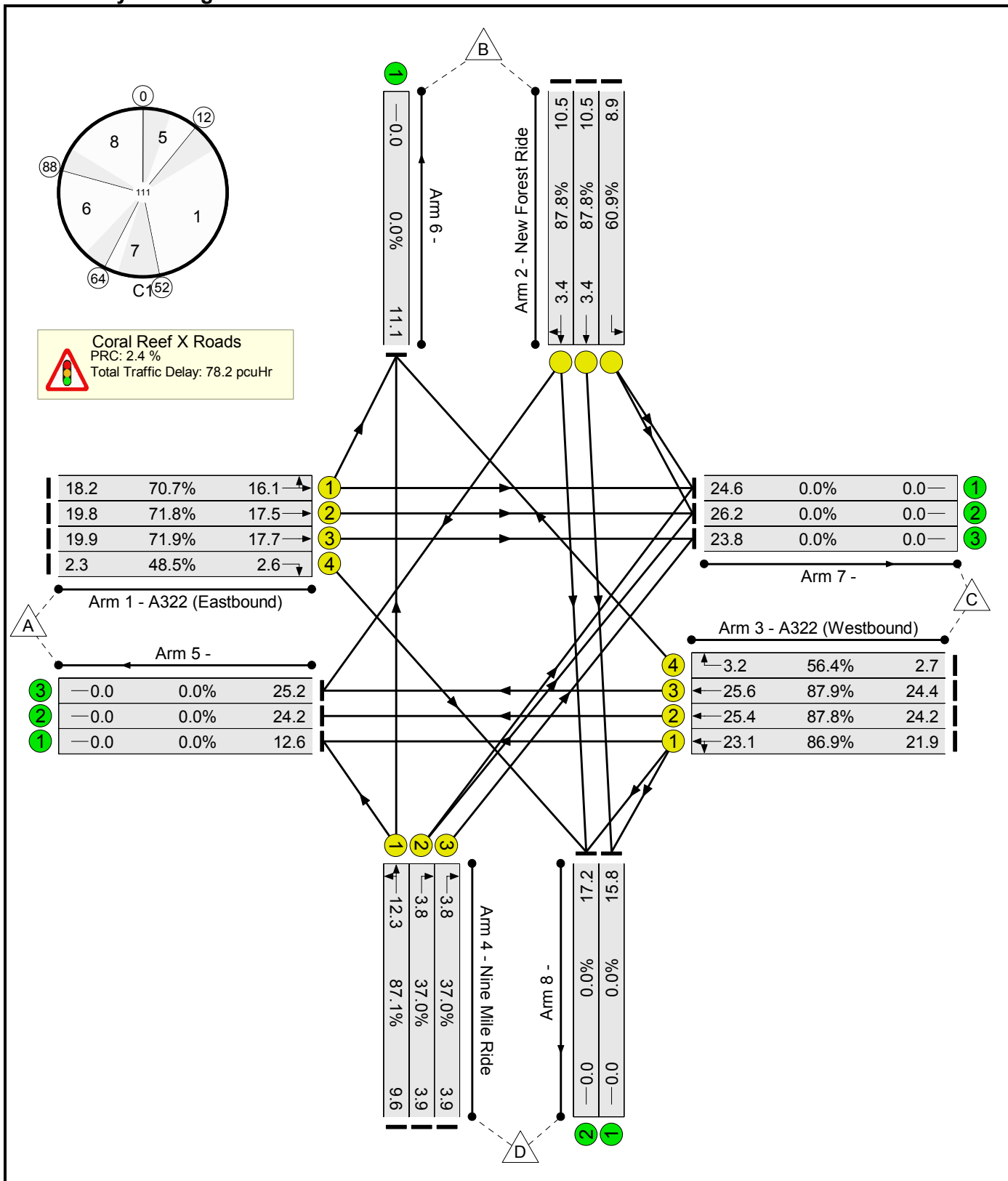

Network Results

Item	Lane Description	Lane Type	Controller Stream	Position In Filtered Route	Full Phase	Arrow Phase	Num Greens	Total Green (s)	Arrow Green (s)	Demand Flow (pcu)	Sat Flow (pcu/Hr)	Capacity (pcu)	Deg Sat (%)
Network: Proposed Crossroads	-	-	N/A	-	-		-	-	-	-	-	-	87.9%
Coral Reef X Roads	-	-	N/A	-	-		-	-	-	-	-	-	87.9%
1/1	A322 (Eastbound) Left Ahead	U	N/A	N/A	A		1	46	-	591	1975	836	70.7%
1/2	A322 (Eastbound) Ahead	U	N/A	N/A	A		1	46	-	643	2115	896	71.8%
1/3	A322 (Eastbound) Ahead	U	N/A	N/A	A		1	46	-	644	2115	896	71.9%
1/4	A322 (Eastbound) Right	U	N/A	N/A	D		1	7	-	74	2115	152	48.5%
2/1	New Forest Ride Left	U	N/A	N/A	G		1	27	-	288	1874	473	60.9%
2/2	New Forest Ride Ahead	U	N/A	N/A	F		1	19	-	341	2155	388	87.8%
2/3	New Forest Ride Right Ahead	U	N/A	N/A	F		1	19	-	341	2155	388	87.8%
3/1	A322 (Westbound) Ahead Left	U	N/A	N/A	B		1	46	-	710	1929	817	86.9%
3/2	A322 (Westbound) Ahead	U	N/A	N/A	B		1	46	-	786	2115	896	87.8%
3/3	A322 (Westbound) Ahead	U	N/A	N/A	B		1	46	-	791	2125	900	87.9%
3/4	A322 (Westbound) Right	U	N/A	N/A	C		1	7	-	86	2115	152	56.4%
4/1	Nine Mile Ride Left Ahead	U	N/A	N/A	E		1	18	-	312	2093	358	87.1%

Full Input Data And Results
 CR Final Layout 20140707.lsg3x

4/2	Nine Mile Ride Right	U	N/A	N/A	E		1	18	-	128	2019	346	37.0%
4/3	Nine Mile Ride Right	U	N/A	N/A	E		1	18	-	128	2019	346	37.0%
5/1		U	N/A	N/A	-		-	-	-	408	Inf	Inf	0.0%
5/2		U	N/A	N/A	-		-	-	-	786	Inf	Inf	0.0%
5/3		U	N/A	N/A	-		-	-	-	818	Inf	Inf	0.0%
6/1		U	N/A	N/A	-		-	-	-	359	Inf	Inf	0.0%
7/1		U	N/A	N/A	-		-	-	-	798	Inf	Inf	0.0%
7/2		U	N/A	N/A	-		-	-	-	851	Inf	Inf	0.0%
7/3		U	N/A	N/A	-		-	-	-	772	Inf	Inf	0.0%
8/1		U	N/A	N/A	-		-	-	-	512	Inf	Inf	0.0%
8/2		U	N/A	N/A	-		-	-	-	559	Inf	Inf	0.0%

Full Input Data And Results
CR Final Layout 20140707.lsg3x

Item	Arriving (pcu)	Leaving (pcu)	Turners In Gaps (pcu)	Turners When Unopposed (pcu)	Turners In Intergreen (pcu)	Uniform Delay (pcuHr)	Rand + Oversat Delay (pcuHr)	Storage Area Uniform Delay (pcuHr)	Total Delay (pcuHr)	Av. Delay Per PCU (s/pcu)	Max. Back of Uniform Queue (pcu)	Rand + Oversat Queue (pcu)	Mean Max Queue (pcu)
Network: Proposed Crossroads	-	-	0	0	0	52.7	25.5	0.0	78.2	-	-	-	-
Coral Reef X Roads	-	-	0	0	0	52.7	25.5	0.0	78.2	-	-	-	-
1/1	591	591	-	-	-	4.3	1.2	-	5.5	33.6	14.9	1.2	16.1
1/2	643	643	-	-	-	4.7	1.3	-	6.0	33.6	16.3	1.3	17.5
1/3	644	644	-	-	-	4.7	1.3	-	6.0	33.6	16.5	1.3	17.7
1/4	74	74	-	-	-	1.0	0.5	-	1.5	72.2	2.2	0.5	2.6
2/1	288	288	-	-	-	2.9	0.8	-	3.7	46.3	7.8	0.8	8.6
2/2	341	341	-	-	-	4.2	3.2	-	7.4	77.9	10.2	3.2	13.4
2/3	341	341	-	-	-	4.2	3.2	-	7.4	77.9	10.2	3.2	13.4
3/1	710	710	-	-	-	5.8	3.1	-	8.9	45.1	19.9	3.1	23.1
3/2	786	786	-	-	-	6.4	3.4	-	9.8	44.8	22.1	3.4	25.4
3/3	791	791	-	-	-	6.5	3.4	-	9.9	45.0	22.2	3.4	25.6
3/4	86	86	-	-	-	1.2	0.6	-	1.8	76.4	2.6	0.6	3.2
4/1	312	312	-	-	-	3.9	3.0	-	6.9	79.3	9.4	3.0	12.3
4/2	128	128	-	-	-	1.4	0.3	-	1.7	49.0	3.5	0.3	3.8
4/3	128	128	-	-	-	1.4	0.3	-	1.7	49.0	3.5	0.3	3.8
5/1	408	408	-	-	-	0.0	0.0	-	0.0	0.0	0.0	0.0	0.0
5/2	786	786	-	-	-	0.0	0.0	-	0.0	0.0	0.0	0.0	0.0
5/3	818	818	-	-	-	0.0	0.0	-	0.0	0.0	0.0	0.0	0.0
6/1	359	359	-	-	-	0.0	0.0	-	0.0	0.0	0.0	0.0	0.0
7/1	798	798	-	-	-	0.0	0.0	-	0.0	0.0	0.0	0.0	0.0
7/2	851	851	-	-	-	0.0	0.0	-	0.0	0.0	0.0	0.0	0.0
7/3	772	772	-	-	-	0.0	0.0	-	0.0	0.0	0.0	0.0	0.0
8/1	512	512	-	-	-	0.0	0.0	-	0.0	0.0	0.0	0.0	0.0
8/2	559	559	-	-	-	0.0	0.0	-	0.0	0.0	0.0	0.0	0.0

Full Input Data And Results
CR Final Layout 20140707.lsg3x

C1	PRC for Signalled Lanes (%):	2.4	Total Delay for Signalled Lanes (pcuHr):	78.21	Cycle Time (s):	111
	PRC Over All Lanes (%):	2.4	Total Delay Over All Lanes(pcuHr):	78.21		

Full Input Data And Results
 CR Final Layout 20140707.lsg3x
Scenario 5: '2013 AM 90%' (FG5: '2013 Observed AM 90%', Plan 1: 'Option1')

Stage Sequence Diagram

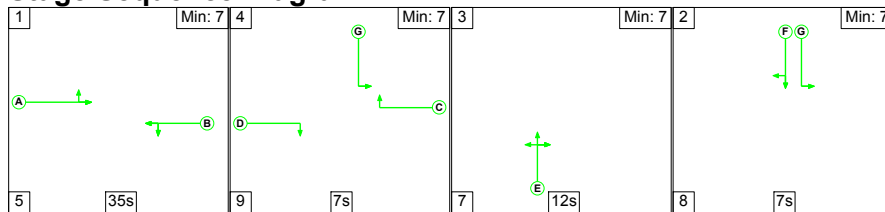

Stage Timings

Stage	1	4	3	2
Duration	35	7	12	7
Change Point	0	40	56	75

Signal Timings Diagram

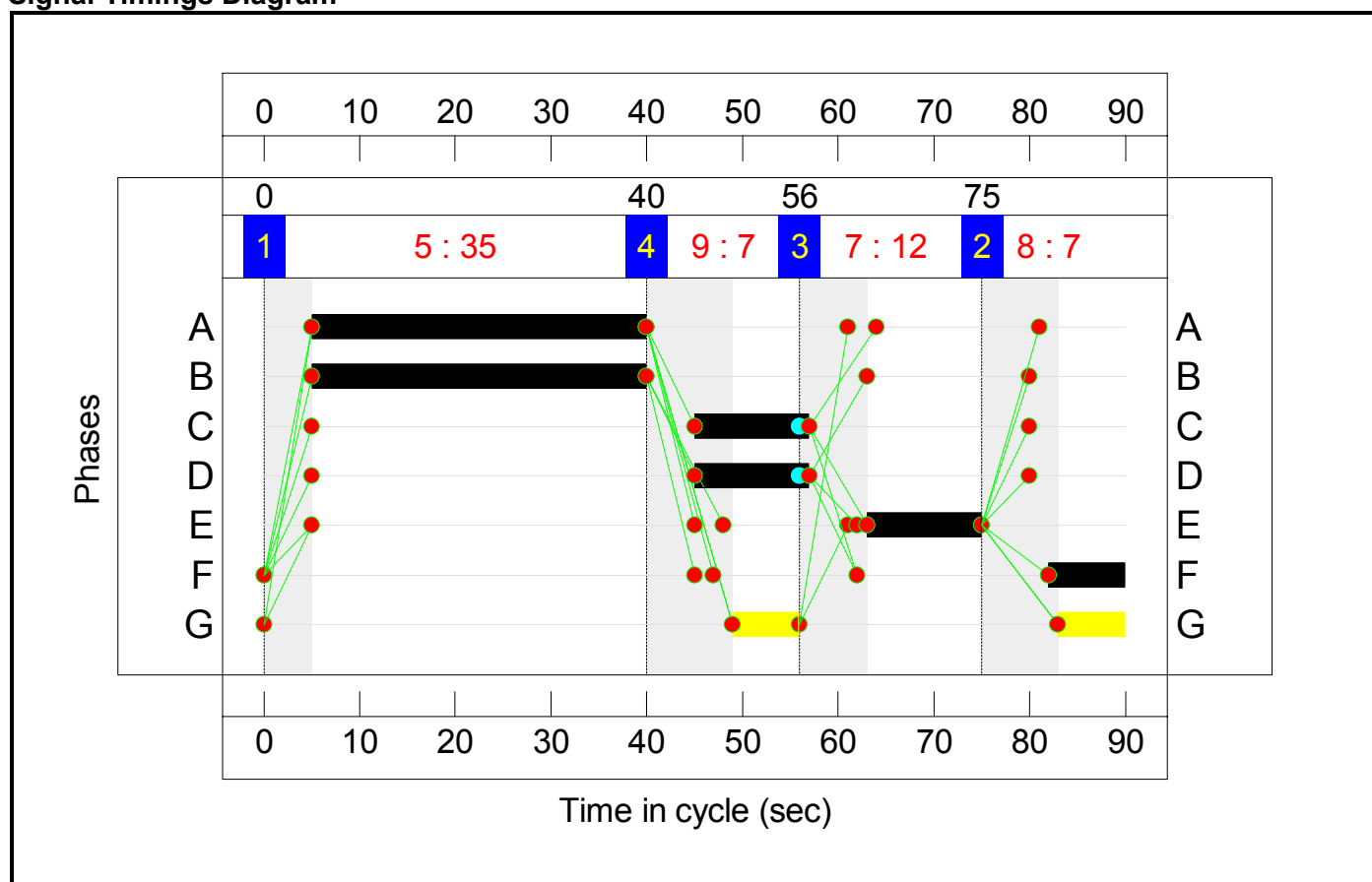

Network Layout Diagram

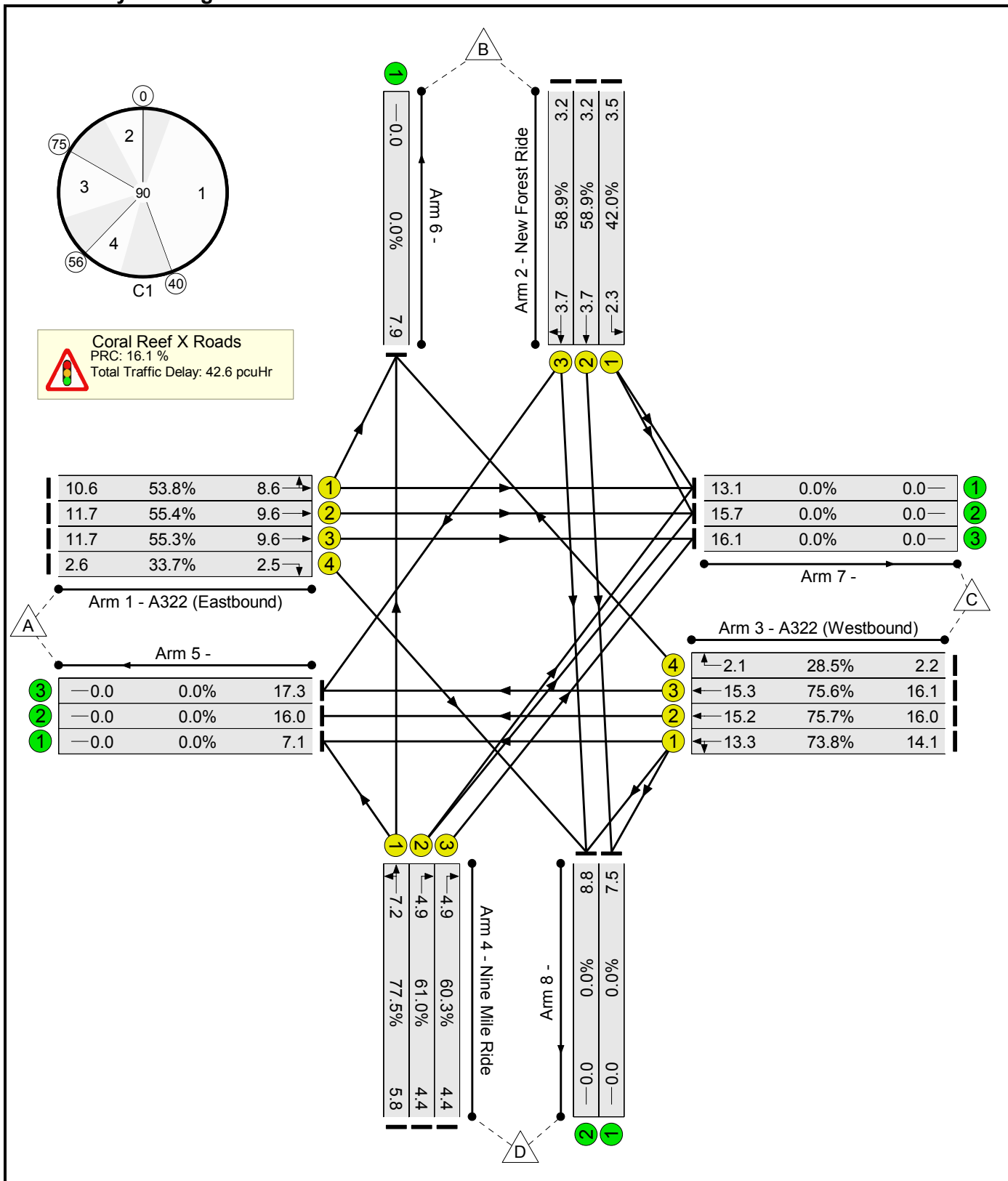

Full Input Data And Results
CR Final Layout 20140707.lsg3x

Network Results

Item	Lane Description	Lane Type	Controller Stream	Position In Filtered Route	Full Phase	Arrow Phase	Num Greens	Total Green (s)	Arrow Green (s)	Demand Flow (pcu)	Sat Flow (pcu/Hr)	Capacity (pcu)	Deg Sat (%)
Network: Proposed Crossroads	-	-	N/A	-	-		-	-	-	-	-	-	77.5%
Coral Reef X Roads	-	-	N/A	-	-		-	-	-	-	-	-	77.5%
1/1	A322 (Eastbound) Left Ahead	U	N/A	N/A	A		1	35	-	425	1975	790	53.8%
1/2	A322 (Eastbound) Ahead	U	N/A	N/A	A		1	35	-	469	2115	846	55.4%
1/3	A322 (Eastbound) Ahead	U	N/A	N/A	A		1	35	-	468	2115	846	55.3%
1/4	A322 (Eastbound) Right	U	N/A	N/A	D		1	12	-	103	2115	305	33.7%
2/1	New Forest Ride Left	U	N/A	N/A	G		2	14	-	140	1874	333	42.0%
2/2	New Forest Ride Ahead	U	N/A	N/A	F		1	8	-	127	2155	215	58.9%
2/3	New Forest Ride Right Ahead	U	N/A	N/A	F		1	8	-	127	2155	215	58.9%
3/1	A322 (Westbound) Ahead Left	U	N/A	N/A	B		1	35	-	566	1917	767	73.8%
3/2	A322 (Westbound) Ahead	U	N/A	N/A	B		1	35	-	640	2115	846	75.7%
3/3	A322 (Westbound) Ahead	U	N/A	N/A	B		1	35	-	643	2125	850	75.6%
3/4	A322 (Westbound) Right	U	N/A	N/A	C		1	12	-	87	2115	305	28.5%
4/1	Nine Mile Ride Left Ahead	U	N/A	N/A	E		1	12	-	231	2063	298	77.5%

Full Input Data And Results
 CR Final Layout 20140707.lsg3x

4/2	Nine Mile Ride Right	U	N/A	N/A	E		1	12	-	178	2019	292	61.0%
4/3	Nine Mile Ride Right	U	N/A	N/A	E		1	12	-	176	2019	292	60.3%
5/1		U	N/A	N/A	-		-	-	-	285	Inf	Inf	0.0%
5/2		U	N/A	N/A	-		-	-	-	640	Inf	Inf	0.0%
5/3		U	N/A	N/A	-		-	-	-	693	Inf	Inf	0.0%
6/1		U	N/A	N/A	-		-	-	-	315	Inf	Inf	0.0%
7/1		U	N/A	N/A	-		-	-	-	523	Inf	Inf	0.0%
7/2		U	N/A	N/A	-		-	-	-	628	Inf	Inf	0.0%
7/3		U	N/A	N/A	-		-	-	-	644	Inf	Inf	0.0%
8/1		U	N/A	N/A	-		-	-	-	300	Inf	Inf	0.0%
8/2		U	N/A	N/A	-		-	-	-	352	Inf	Inf	0.0%

Full Input Data And Results
CR Final Layout 20140707.lsg3x

Item	Arriving (pcu)	Leaving (pcu)	Turners In Gaps (pcu)	Turners When Unopposed (pcu)	Turners In Intergreen (pcu)	Uniform Delay (pcuHr)	Rand + Oversat Delay (pcuHr)	Storage Area Uniform Delay (pcuHr)	Total Delay (pcuHr)	Av. Delay Per PCU (s/pcu)	Max. Back of Uniform Queue (pcu)	Rand + Oversat Queue (pcu)	Mean Max Queue (pcu)
Network: Proposed Crossroads	-	-	0	0	0	30.9	11.7	0.0	42.6	-	-	-	-
Coral Reef X Roads	-	-	0	0	0	30.9	11.7	0.0	42.6	-	-	-	-
1/1	425	425	-	-	-	2.4	0.6	-	3.0	25.6	8.0	0.6	8.6
1/2	469	469	-	-	-	2.7	0.6	-	3.3	25.6	9.0	0.6	9.6
1/3	468	468	-	-	-	2.7	0.6	-	3.3	25.6	9.0	0.6	9.6
1/4	103	103	-	-	-	1.0	0.3	-	1.2	43.5	2.3	0.3	2.5
2/1	140	140	-	-	-	0.7	0.4	-	1.1	27.2	2.0	0.4	2.3
2/2	127	127	-	-	-	1.4	0.7	-	2.1	58.8	3.0	0.7	3.7
2/3	127	127	-	-	-	1.4	0.7	-	2.1	58.8	3.0	0.7	3.7
3/1	566	566	-	-	-	3.6	1.4	-	5.0	31.8	11.9	1.4	13.3
3/2	640	640	-	-	-	4.1	1.5	-	5.7	31.8	13.7	1.5	15.2
3/3	643	643	-	-	-	4.1	1.5	-	5.7	31.8	13.8	1.5	15.3
3/4	87	87	-	-	-	0.8	0.2	-	1.0	42.6	1.9	0.2	2.1
4/1	231	231	-	-	-	2.4	1.6	-	4.0	62.7	5.5	1.6	7.2
4/2	178	178	-	-	-	1.8	0.8	-	2.6	51.8	4.2	0.8	4.9
4/3	176	176	-	-	-	1.8	0.8	-	2.5	51.5	4.1	0.8	4.9
5/1	285	285	-	-	-	0.0	0.0	-	0.0	0.0	0.0	0.0	0.0
5/2	640	640	-	-	-	0.0	0.0	-	0.0	0.0	0.0	0.0	0.0
5/3	693	693	-	-	-	0.0	0.0	-	0.0	0.0	0.0	0.0	0.0
6/1	315	315	-	-	-	0.0	0.0	-	0.0	0.0	0.0	0.0	0.0
7/1	523	523	-	-	-	0.0	0.0	-	0.0	0.0	0.0	0.0	0.0
7/2	628	628	-	-	-	0.0	0.0	-	0.0	0.0	0.0	0.0	0.0
7/3	644	644	-	-	-	0.0	0.0	-	0.0	0.0	0.0	0.0	0.0
8/1	300	300	-	-	-	0.0	0.0	-	0.0	0.0	0.0	0.0	0.0
8/2	352	352	-	-	-	0.0	0.0	-	0.0	0.0	0.0	0.0	0.0

Full Input Data And Results
CR Final Layout 20140707.lsg3x

C1	PRC for Signalled Lanes (%):	16.1	Total Delay for Signalled Lanes (pcuHr):	42.59	Cycle Time (s):	90
	PRC Over All Lanes (%):	16.1	Total Delay Over All Lanes(pcuHr):	42.59		

Full Input Data And Results

CR Final Layout 20140707.lsg3x

Scenario 6: '2013 PM 90%' (FG6: '2013 Observed PM 90%', Plan 1: 'Option1')

Stage Sequence Diagram

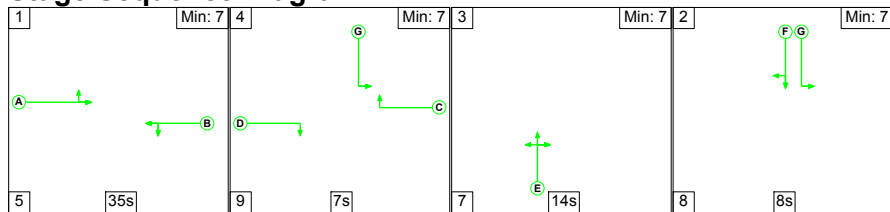

Stage Timings

Stage	1	4	3	2
Duration	35	7	14	8
Change Point	0	40	56	77

Signal Timings Diagram

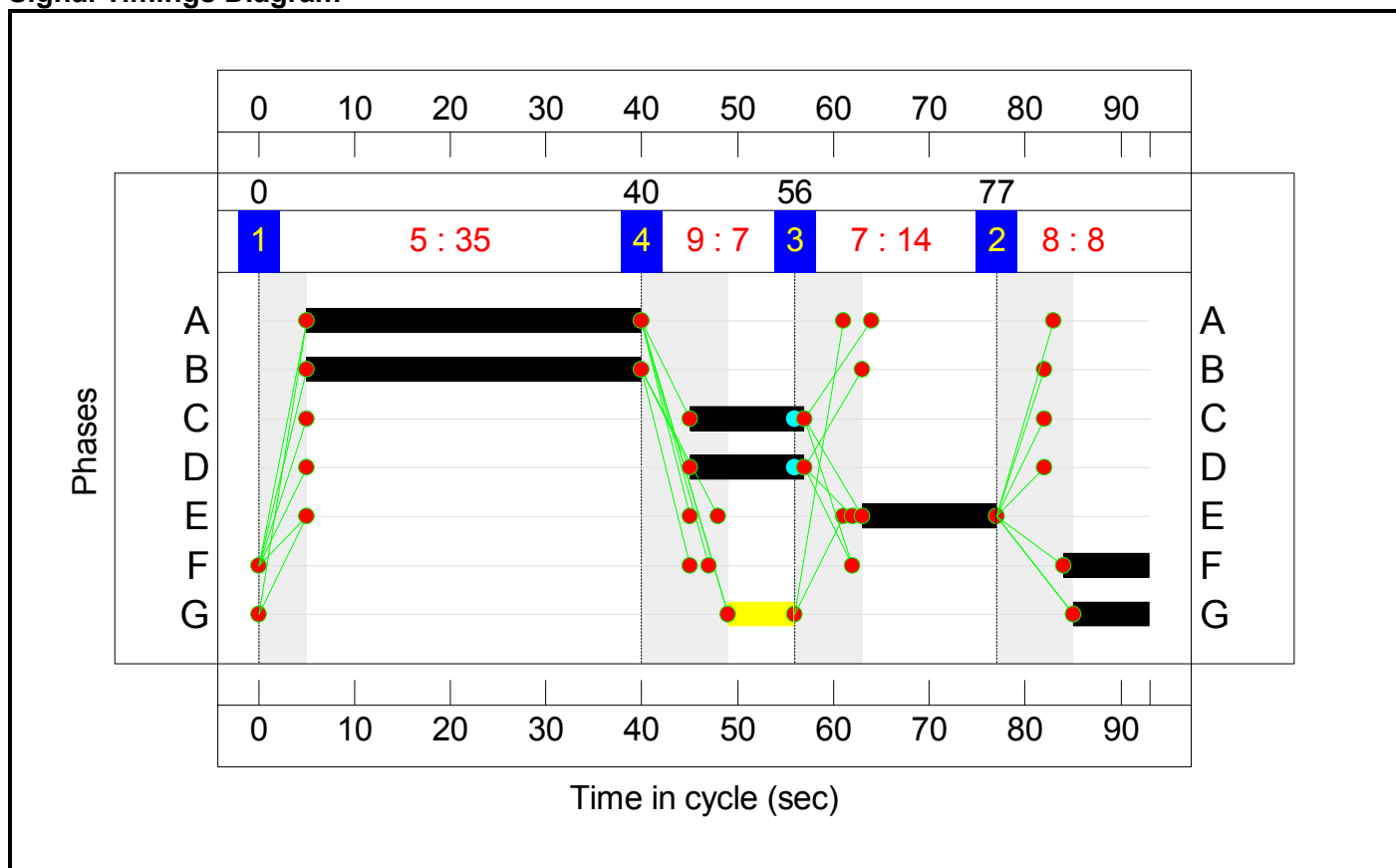

Network Layout Diagram

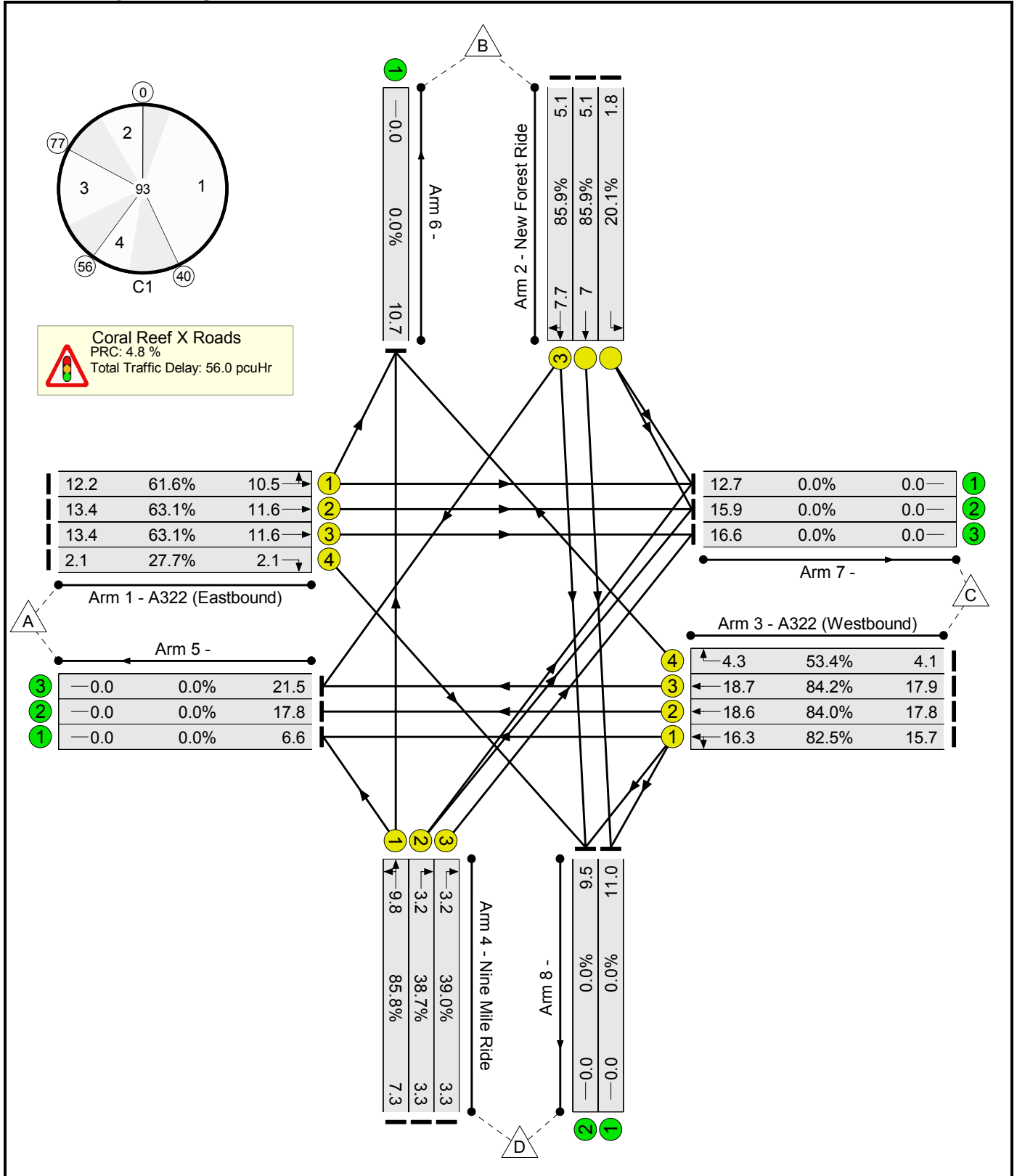

Full Input Data And Results
CR Final Layout 20140707.lsg3x

Network Results

Item	Lane Description	Lane Type	Controller Stream	Position In Filtered Route	Full Phase	Arrow Phase	Num Greens	Total Green (s)	Arrow Green (s)	Demand Flow (pcu)	Sat Flow (pcu/Hr)	Capacity (pcu)	Deg Sat (%)
Network: Proposed Crossroads	-	-	N/A	-	-		-	-	-	-	-	-	85.9%
Coral Reef X Roads	-	-	N/A	-	-		-	-	-	-	-	-	85.9%
1/1	A322 (Eastbound) Left Ahead	U	N/A	N/A	A		1	35	-	471	1975	765	61.6%
1/2	A322 (Eastbound) Ahead	U	N/A	N/A	A		1	35	-	517	2115	819	63.1%
1/3	A322 (Eastbound) Ahead	U	N/A	N/A	A		1	35	-	517	2115	819	63.1%
1/4	A322 (Eastbound) Right	U	N/A	N/A	D		1	12	-	82	2115	296	27.7%
2/1	New Forest Ride Left	U	N/A	N/A	G		2	15	-	69	1874	343	20.1%
2/2	New Forest Ride Ahead	U	N/A	N/A	F		1	9	-	199	2155	232	85.9%
2/3	New Forest Ride Right Ahead	U	N/A	N/A	F		1	9	-	199	2155	232	85.9%
3/1	A322 (Westbound) Ahead Left	U	N/A	N/A	B		1	35	-	608	1904	737	82.5%
3/2	A322 (Westbound) Ahead	U	N/A	N/A	B		1	35	-	688	2115	819	84.0%
3/3	A322 (Westbound) Ahead	U	N/A	N/A	B		1	35	-	693	2125	823	84.2%
3/4	A322 (Westbound) Right	U	N/A	N/A	C		1	12	-	158	2115	296	53.4%
4/1	Nine Mile Ride Left Ahead	U	N/A	N/A	E		1	14	-	283	2045	330	85.8%

Full Input Data And Results
 CR Final Layout 20140707.lsg3x

4/2	Nine Mile Ride Right	U	N/A	N/A	E		1	14	-	126	2019	326	38.7%
4/3	Nine Mile Ride Right	U	N/A	N/A	E		1	14	-	127	2019	326	39.0%
5/1		U	N/A	N/A	-		-	-	-	257	Inf	Inf	0.0%
5/2		U	N/A	N/A	-		-	-	-	688	Inf	Inf	0.0%
5/3		U	N/A	N/A	-		-	-	-	833	Inf	Inf	0.0%
6/1		U	N/A	N/A	-		-	-	-	414	Inf	Inf	0.0%
7/1		U	N/A	N/A	-		-	-	-	491	Inf	Inf	0.0%
7/2		U	N/A	N/A	-		-	-	-	615	Inf	Inf	0.0%
7/3		U	N/A	N/A	-		-	-	-	644	Inf	Inf	0.0%
8/1		U	N/A	N/A	-		-	-	-	427	Inf	Inf	0.0%
8/2		U	N/A	N/A	-		-	-	-	368	Inf	Inf	0.0%

Full Input Data And Results
CR Final Layout 20140707.lsg3x

Item	Arriving (pcu)	Leaving (pcu)	Turners In Gaps (pcu)	Turners When Unopposed (pcu)	Turners In Intergreen (pcu)	Uniform Delay (pcuHr)	Rand + Oversat Delay (pcuHr)	Storage Area Uniform Delay (pcuHr)	Total Delay (pcuHr)	Av. Delay Per PCU (s/pcu)	Max. Back of Uniform Queue (pcu)	Rand + Oversat Queue (pcu)	Mean Max Queue (pcu)
Network: Proposed Crossroads	-	-	0	0	0	36.6	19.4	0.0	56.0	-	-	-	-
Coral Reef X Roads	-	-	0	0	0	36.6	19.4	0.0	56.0	-	-	-	-
1/1	471	471	-	-	-	3.0	0.8	-	3.8	29.0	9.7	0.8	10.5
1/2	517	517	-	-	-	3.3	0.9	-	4.2	29.1	10.8	0.9	11.6
1/3	517	517	-	-	-	3.3	0.9	-	4.2	29.1	10.8	0.9	11.6
1/4	82	82	-	-	-	0.8	0.2	-	1.0	44.2	1.9	0.2	2.1
2/1	69	69	-	-	-	0.3	0.1	-	0.5	23.8	0.9	0.1	1.1
2/2	199	199	-	-	-	2.3	2.6	-	4.9	88.2	5.0	2.6	7.7
2/3	199	199	-	-	-	2.3	2.6	-	4.9	88.2	5.0	2.6	7.7
3/1	608	608	-	-	-	4.3	2.3	-	6.6	39.1	14.0	2.3	16.3
3/2	688	688	-	-	-	4.9	2.5	-	7.5	39.1	16.1	2.5	18.6
3/3	693	693	-	-	-	5.0	2.6	-	7.6	39.3	16.2	2.6	18.7
3/4	158	158	-	-	-	1.6	0.6	-	2.2	50.2	3.8	0.6	4.3
4/1	283	283	-	-	-	3.0	2.7	-	5.7	72.4	7.1	2.7	9.8
4/2	126	126	-	-	-	1.2	0.3	-	1.5	43.9	2.9	0.3	3.2
4/3	127	127	-	-	-	1.2	0.3	-	1.6	44.0	2.9	0.3	3.2
5/1	257	257	-	-	-	0.0	0.0	-	0.0	0.0	0.0	0.0	0.0
5/2	688	688	-	-	-	0.0	0.0	-	0.0	0.0	0.0	0.0	0.0
5/3	833	833	-	-	-	0.0	0.0	-	0.0	0.0	0.0	0.0	0.0
6/1	414	414	-	-	-	0.0	0.0	-	0.0	0.0	0.0	0.0	0.0
7/1	491	491	-	-	-	0.0	0.0	-	0.0	0.0	0.0	0.0	0.0
7/2	615	615	-	-	-	0.0	0.0	-	0.0	0.0	0.0	0.0	0.0
7/3	644	644	-	-	-	0.0	0.0	-	0.0	0.0	0.0	0.0	0.0
8/1	427	427	-	-	-	0.0	0.0	-	0.0	0.0	0.0	0.0	0.0
8/2	368	368	-	-	-	0.0	0.0	-	0.0	0.0	0.0	0.0	0.0

Full Input Data And Results
CR Final Layout 20140707.lsg3x

C1	PRC for Signalled Lanes (%):	4.8	Total Delay for Signalled Lanes (pcuHr):	56.00	Cycle Time (s):	93
	PRC Over All Lanes (%):	4.8	Total Delay Over All Lanes(pcuHr):	56.00		

Full Input Data And Results
 CR Final Layout 20140707.lsg3x
Scenario 7: '2026 AM 90%' (FG7: '2026 M3 AM 90%', Plan 1: 'Option1')

Stage Sequence Diagram

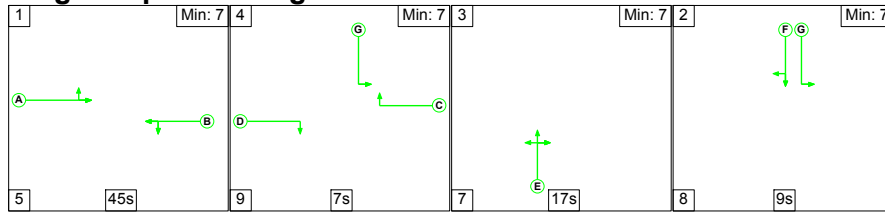

Stage Timings

Stage	1	4	3	2
Duration	45	7	17	9
Change Point	0	50	66	90

Signal Timings Diagram

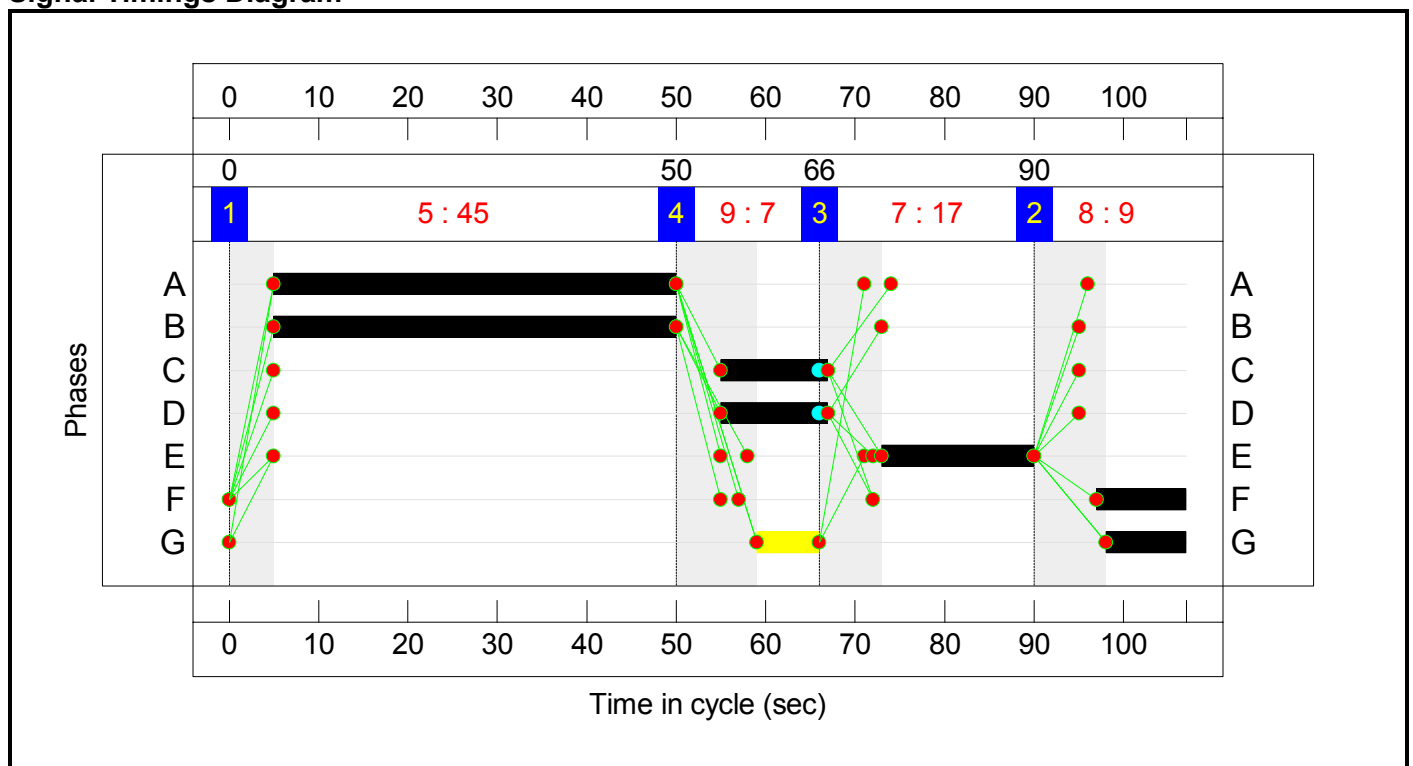

Network Layout Diagram

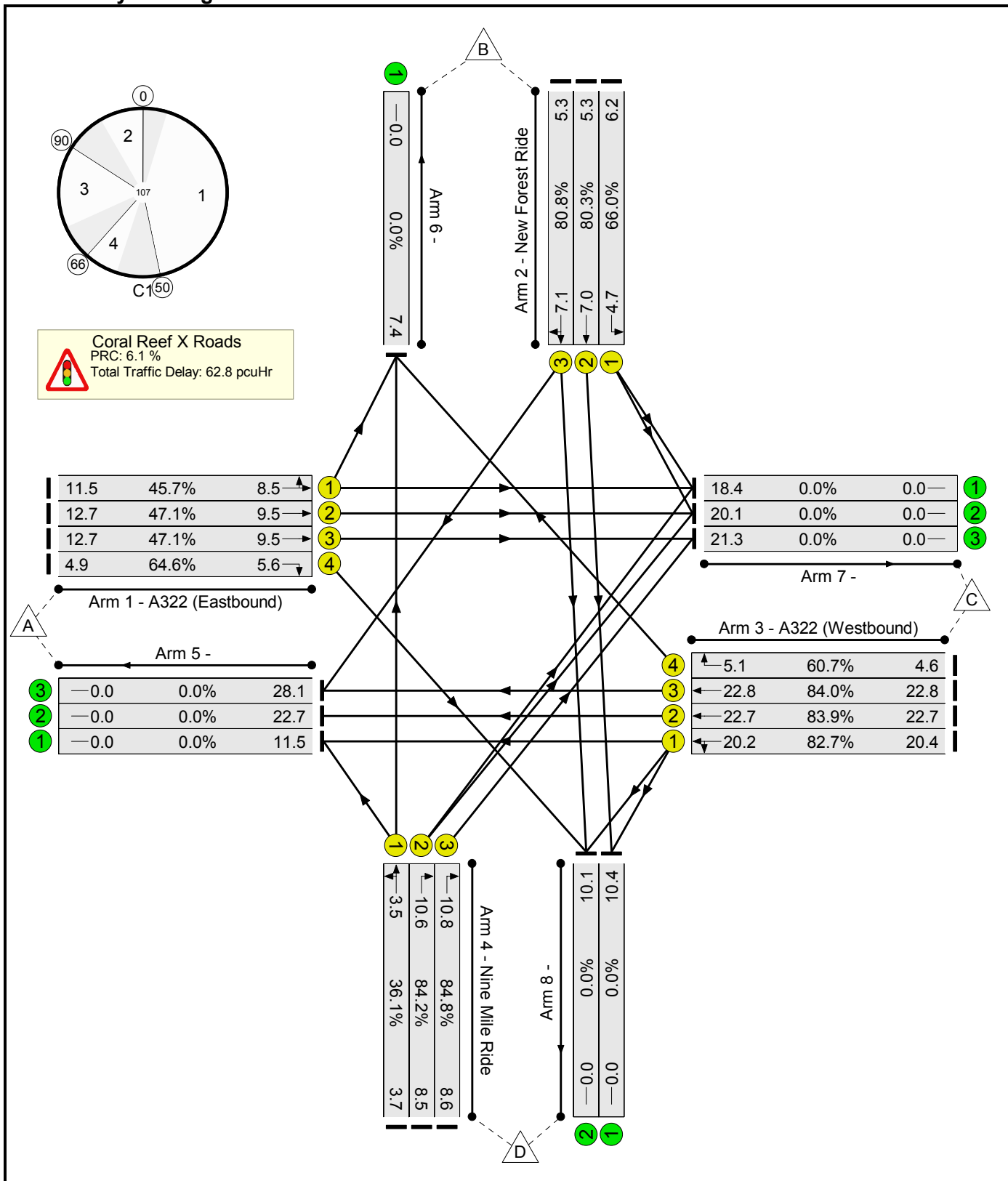

Network Results

Item	Lane Description	Lane Type	Controller Stream	Position In Filtered Route	Full Phase	Arrow Phase	Num Greens	Total Green (s)	Arrow Green (s)	Demand Flow (pcu)	Sat Flow (pcu/Hr)	Capacity (pcu)	Deg Sat (%)
Network: Proposed Crossroads	-	-	N/A	-	-		-	-	-	-	-	-	84.8%
Coral Reef X Roads	-	-	N/A	-	-		-	-	-	-	-	-	84.8%
1/1	A322 (Eastbound) Left Ahead	U	N/A	N/A	A		1	45	-	388	1975	849	45.7%
1/2	A322 (Eastbound) Ahead	U	N/A	N/A	A		1	45	-	428	2115	909	47.1%
1/3	A322 (Eastbound) Ahead	U	N/A	N/A	A		1	45	-	428	2115	909	47.1%
1/4	A322 (Eastbound) Right	U	N/A	N/A	D		1	12	-	166	2115	257	64.6%
2/1	New Forest Ride Left	U	N/A	N/A	G		2	16	-	208	1874	315	66.0%
2/2	New Forest Ride Ahead	U	N/A	N/A	F		1	10	-	178	2155	222	80.3%
2/3	New Forest Ride Right Ahead	U	N/A	N/A	F		1	10	-	179	2155	222	80.8%
3/1	A322 (Westbound) Ahead Left	U	N/A	N/A	B		1	45	-	685	1926	828	82.7%
3/2	A322 (Westbound) Ahead	U	N/A	N/A	B		1	45	-	763	2115	909	83.9%
3/3	A322 (Westbound) Ahead	U	N/A	N/A	B		1	45	-	767	2125	914	84.0%
3/4	A322 (Westbound) Right	U	N/A	N/A	C		1	12	-	156	2115	257	60.7%
4/1	Nine Mile Ride Left Ahead	U	N/A	N/A	E		1	17	-	124	2043	344	36.1%

Full Input Data And Results
 CR Final Layout 20140707.lsg3x

4/2	Nine Mile Ride Right	U	N/A	N/A	E		1	17	-	286	2019	340	84.2%
4/3	Nine Mile Ride Right	U	N/A	N/A	E		1	17	-	288	2019	340	84.8%
5/1		U	N/A	N/A	-		-	-	-	386	Inf	Inf	0.0%
5/2		U	N/A	N/A	-		-	-	-	763	Inf	Inf	0.0%
5/3		U	N/A	N/A	-		-	-	-	946	Inf	Inf	0.0%
6/1		U	N/A	N/A	-		-	-	-	248	Inf	Inf	0.0%
7/1		U	N/A	N/A	-		-	-	-	620	Inf	Inf	0.0%
7/2		U	N/A	N/A	-		-	-	-	675	Inf	Inf	0.0%
7/3		U	N/A	N/A	-		-	-	-	716	Inf	Inf	0.0%
8/1		U	N/A	N/A	-		-	-	-	351	Inf	Inf	0.0%
8/2		U	N/A	N/A	-		-	-	-	339	Inf	Inf	0.0%

Full Input Data And Results
CR Final Layout 20140707.lsg3x

Item	Arriving (pcu)	Leaving (pcu)	Turners In Gaps (pcu)	Turners When Unopposed (pcu)	Turners In Intergreen (pcu)	Uniform Delay (pcuHr)	Rand + Oversat Delay (pcuHr)	Storage Area Uniform Delay (pcuHr)	Total Delay (pcuHr)	Av. Delay Per PCU (s/pcu)	Max. Back of Uniform Queue (pcu)	Rand + Oversat Queue (pcu)	Mean Max Queue (pcu)
Network: Proposed Crossroads	-	-	0	0	0	42.4	20.4	0.0	62.8	-	-	-	-
Coral Reef X Roads	-	-	0	0	0	42.4	20.4	0.0	62.8	-	-	-	-
1/1	388	388	-	-	-	2.3	0.4	-	2.8	25.5	8.1	0.4	8.5
1/2	428	428	-	-	-	2.6	0.4	-	3.0	25.5	9.0	0.4	9.5
1/3	428	428	-	-	-	2.6	0.4	-	3.0	25.5	9.0	0.4	9.5
1/4	166	166	-	-	-	2.1	0.9	-	3.0	64.2	4.7	0.9	5.6
2/1	208	208	-	-	-	1.3	1.0	-	2.3	39.2	3.8	1.0	4.7
2/2	178	178	-	-	-	2.3	1.9	-	4.2	85.0	5.1	1.9	7.0
2/3	179	179	-	-	-	2.3	1.9	-	4.3	85.8	5.2	1.9	7.1
3/1	685	685	-	-	-	5.1	2.3	-	7.5	39.2	17.9	2.3	20.2
3/2	763	763	-	-	-	5.8	2.5	-	8.3	39.1	20.1	2.5	22.7
3/3	767	767	-	-	-	5.8	2.5	-	8.3	39.1	20.2	2.5	22.8
3/4	156	156	-	-	-	1.9	0.8	-	2.7	62.2	4.4	0.8	5.1
4/1	124	124	-	-	-	1.4	0.3	-	1.6	47.6	3.2	0.3	3.5
4/2	286	286	-	-	-	3.4	2.4	-	5.9	73.9	8.2	2.4	10.6
4/3	288	288	-	-	-	3.5	2.5	-	6.0	74.9	8.2	2.5	10.8
5/1	386	386	-	-	-	0.0	0.0	-	0.0	0.0	0.0	0.0	0.0
5/2	763	763	-	-	-	0.0	0.0	-	0.0	0.0	0.0	0.0	0.0
5/3	946	946	-	-	-	0.0	0.0	-	0.0	0.0	0.0	0.0	0.0
6/1	248	248	-	-	-	0.0	0.0	-	0.0	0.0	0.0	0.0	0.0
7/1	620	620	-	-	-	0.0	0.0	-	0.0	0.0	0.0	0.0	0.0
7/2	675	675	-	-	-	0.0	0.0	-	0.0	0.0	0.0	0.0	0.0
7/3	716	716	-	-	-	0.0	0.0	-	0.0	0.0	0.0	0.0	0.0
8/1	351	351	-	-	-	0.0	0.0	-	0.0	0.0	0.0	0.0	0.0
8/2	339	339	-	-	-	0.0	0.0	-	0.0	0.0	0.0	0.0	0.0

Full Input Data And Results
CR Final Layout 20140707.lsg3x

C1	PRC for Signalled Lanes (%):	6.1	Total Delay for Signalled Lanes (pcuHr):	62.78	Cycle Time (s):	107
	PRC Over All Lanes (%):	6.1	Total Delay Over All Lanes(pcuHr):	62.78		

Full Input Data And Results
 CR Final Layout 20140707.lsg3x
Scenario 8: '2026 PM 90%' (FG8: '2026 M3 PM 90%', Plan 1: 'Option1')

Stage Sequence Diagram

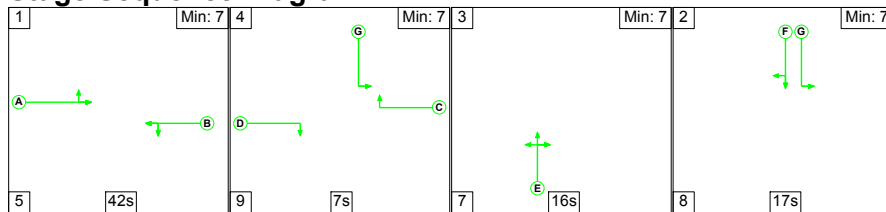

Stage Timings

Stage	1	4	3	2
Duration	42	7	16	17
Change Point	0	47	63	86

Signal Timings Diagram

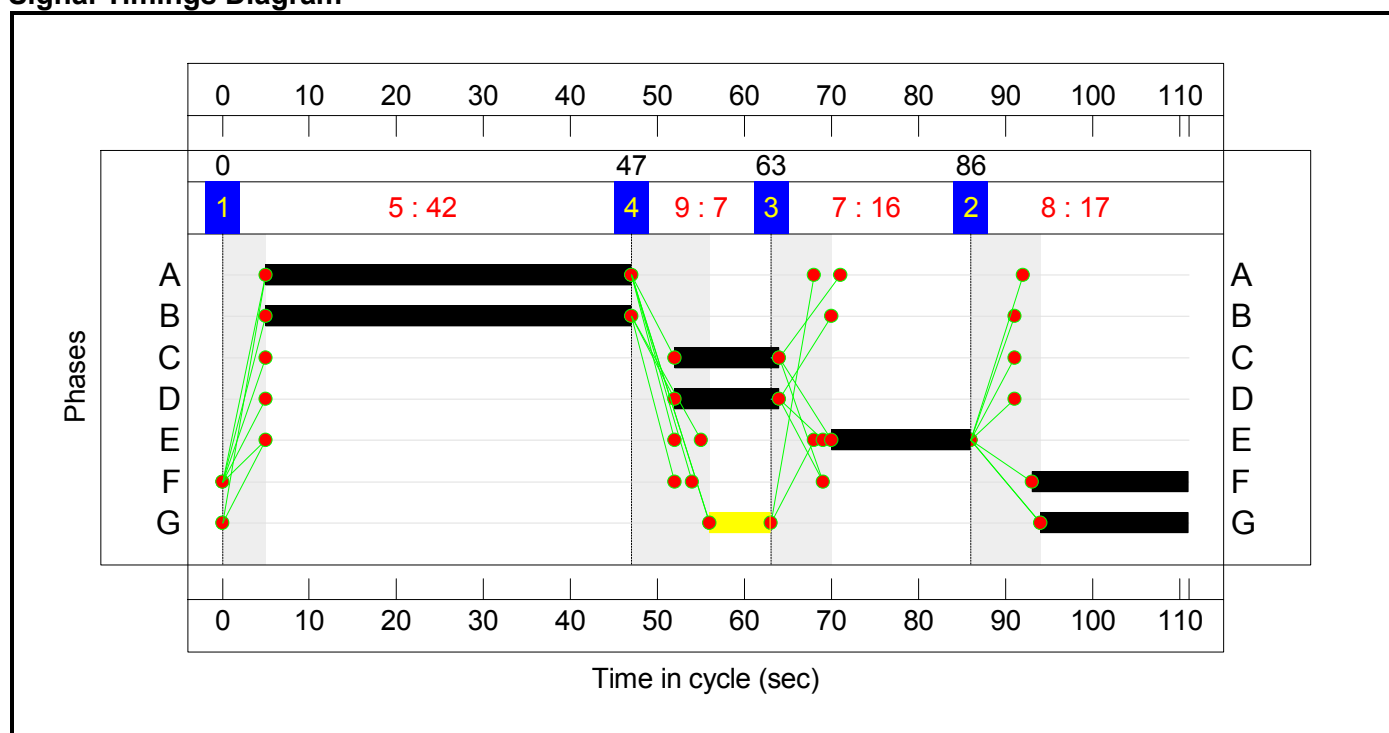

Network Layout Diagram

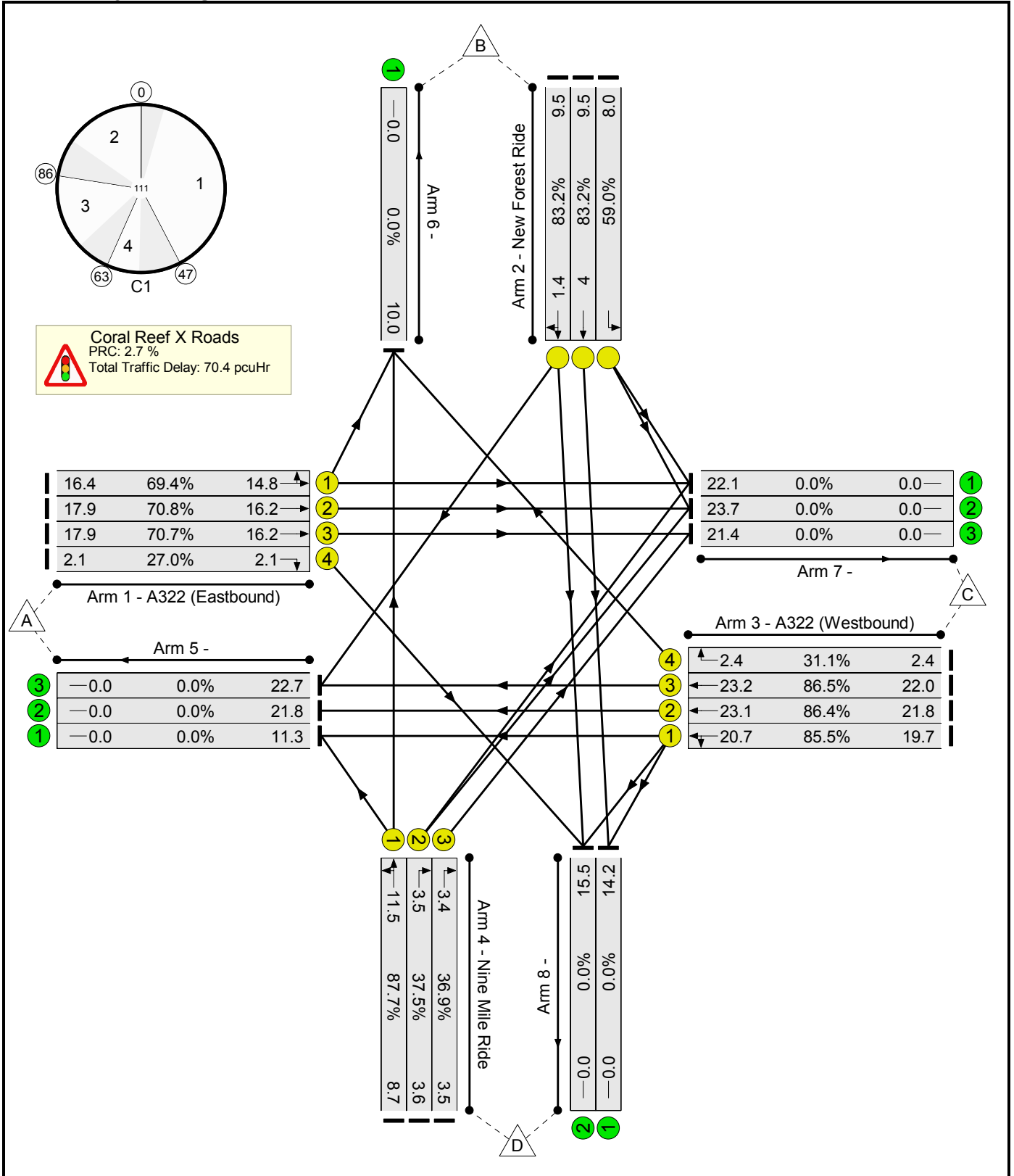

Full Input Data And Results
CR Final Layout 20140707.lsg3x

Network Results

Item	Lane Description	Lane Type	Controller Stream	Position In Filtered Route	Full Phase	Arrow Phase	Num Greens	Total Green (s)	Arrow Green (s)	Demand Flow (pcu)	Sat Flow (pcu/Hr)	Capacity (pcu)	Deg Sat (%)
Network: Proposed Crossroads	-	-	N/A	-	-		-	-	-	-	-	-	87.7%
Coral Reef X Roads	-	-	N/A	-	-		-	-	-	-	-	-	87.7%
1/1	A322 (Eastbound) Left Ahead	U	N/A	N/A	A		1	42	-	531	1975	765	69.4%
1/2	A322 (Eastbound) Ahead	U	N/A	N/A	A		1	42	-	580	2115	819	70.8%
1/3	A322 (Eastbound) Ahead	U	N/A	N/A	A		1	42	-	579	2115	819	70.7%
1/4	A322 (Eastbound) Right	U	N/A	N/A	D		1	12	-	67	2115	248	27.0%
2/1	New Forest Ride Left	U	N/A	N/A	G		2	24	-	259	1874	439	59.0%
2/2	New Forest Ride Ahead	U	N/A	N/A	F		1	18	-	307	2155	369	83.2%
2/3	New Forest Ride Right Ahead	U	N/A	N/A	F		1	18	-	307	2155	369	83.2%
3/1	A322 (Westbound) Ahead Left	U	N/A	N/A	B		1	42	-	639	1929	747	85.5%
3/2	A322 (Westbound) Ahead	U	N/A	N/A	B		1	42	-	708	2115	819	86.4%
3/3	A322 (Westbound) Ahead	U	N/A	N/A	B		1	42	-	712	2125	823	86.5%
3/4	A322 (Westbound) Right	U	N/A	N/A	C		1	12	-	77	2115	248	31.1%
4/1	Nine Mile Ride Left Ahead	U	N/A	N/A	E		1	16	-	281	2093	321	87.7%

Full Input Data And Results
 CR Final Layout 20140707.lsg3x

4/2	Nine Mile Ride Right	U	N/A	N/A	E		1	16	-	116	2019	309	37.5%
4/3	Nine Mile Ride Right	U	N/A	N/A	E		1	16	-	114	2019	309	36.9%
5/1		U	N/A	N/A	-		-	-	-	367	Inf	Inf	0.0%
5/2		U	N/A	N/A	-		-	-	-	708	Inf	Inf	0.0%
5/3		U	N/A	N/A	-		-	-	-	736	Inf	Inf	0.0%
6/1		U	N/A	N/A	-		-	-	-	323	Inf	Inf	0.0%
7/1		U	N/A	N/A	-		-	-	-	717	Inf	Inf	0.0%
7/2		U	N/A	N/A	-		-	-	-	768	Inf	Inf	0.0%
7/3		U	N/A	N/A	-		-	-	-	693	Inf	Inf	0.0%
8/1		U	N/A	N/A	-		-	-	-	461	Inf	Inf	0.0%
8/2		U	N/A	N/A	-		-	-	-	504	Inf	Inf	0.0%

Full Input Data And Results
CR Final Layout 20140707.lsg3x

Item	Arriving (pcu)	Leaving (pcu)	Turners In Gaps (pcu)	Turners When Unopposed (pcu)	Turners In Intergreen (pcu)	Uniform Delay (pcuHr)	Rand + Oversat Delay (pcuHr)	Storage Area Uniform Delay (pcuHr)	Total Delay (pcuHr)	Av. Delay Per PCU (s/pcu)	Max. Back of Uniform Queue (pcu)	Rand + Oversat Queue (pcu)	Mean Max Queue (pcu)
Network: Proposed Crossroads	-	-	0	0	0	48.6	21.8	0.0	70.4	-	-	-	-
Coral Reef X Roads	-	-	0	0	0	48.6	21.8	0.0	70.4	-	-	-	-
1/1	531	531	-	-	-	4.2	1.1	-	5.3	36.1	13.7	1.1	14.8
1/2	580	580	-	-	-	4.6	1.2	-	5.8	36.1	15.0	1.2	16.2
1/3	579	579	-	-	-	4.6	1.2	-	5.8	36.1	15.0	1.2	16.2
1/4	67	67	-	-	-	0.8	0.2	-	1.0	54.6	1.9	0.2	2.1
2/1	259	259	-	-	-	1.6	0.7	-	2.3	32.1	4.5	0.7	5.2
2/2	307	307	-	-	-	3.8	2.3	-	6.1	71.5	9.1	2.3	11.4
2/3	307	307	-	-	-	3.8	2.3	-	6.1	71.5	9.1	2.3	11.4
3/1	639	639	-	-	-	5.5	2.8	-	8.3	47.0	17.9	2.8	20.7
3/2	708	708	-	-	-	6.2	3.0	-	9.2	46.6	20.1	3.0	23.1
3/3	712	712	-	-	-	6.2	3.0	-	9.2	46.7	20.2	3.0	23.2
3/4	77	77	-	-	-	1.0	0.2	-	1.2	55.4	2.2	0.2	2.4
4/1	281	281	-	-	-	3.6	3.1	-	6.7	85.4	8.4	3.1	11.5
4/2	116	116	-	-	-	1.4	0.3	-	1.7	51.5	3.2	0.3	3.5
4/3	114	114	-	-	-	1.3	0.3	-	1.6	51.4	3.1	0.3	3.4
5/1	367	367	-	-	-	0.0	0.0	-	0.0	0.0	0.0	0.0	0.0
5/2	708	708	-	-	-	0.0	0.0	-	0.0	0.0	0.0	0.0	0.0
5/3	736	736	-	-	-	0.0	0.0	-	0.0	0.0	0.0	0.0	0.0
6/1	323	323	-	-	-	0.0	0.0	-	0.0	0.0	0.0	0.0	0.0
7/1	717	717	-	-	-	0.0	0.0	-	0.0	0.0	0.0	0.0	0.0
7/2	768	768	-	-	-	0.0	0.0	-	0.0	0.0	0.0	0.0	0.0
7/3	693	693	-	-	-	0.0	0.0	-	0.0	0.0	0.0	0.0	0.0
8/1	461	461	-	-	-	0.0	0.0	-	0.0	0.0	0.0	0.0	0.0
8/2	504	504	-	-	-	0.0	0.0	-	0.0	0.0	0.0	0.0	0.0

Full Input Data And Results
CR Final Layout 20140707.lsg3x

C1	PRC for Signalled Lanes (%):	2.7	Total Delay for Signalled Lanes (pcuHr):	70.36	Cycle Time (s):	111
	PRC Over All Lanes (%):	2.7	Total Delay Over All Lanes(pcuHr):	70.36		